



Aménageur d'Espaces...

[www.mbs95.com](http://www.mbs95.com)

15, rue de la Briqueterie 95330 DOMONT  
Tél. 01 39 35 41 80 Fax 01 39 35 41 76 [commercial@mbs95.com](mailto:commercial@mbs95.com)

# corbetta

CONTRACT

TABLES

























CHAIRS

2022



# corbetta

## TABLE BASES

	mondrian ..... pag. 12	rubik ..... pag. 68	
	madrid ..... pag. 18	bomb ..... pag. 72	
	matias ..... pag. 22	cono ..... pag. 74	
	tetris ..... pag. 26	power ..... pag. 76	
	petal ..... pag. 30	kora ..... pag. 80	
	petal big one ... pag. 38	lift ..... pag. 84	
	petal big four ... pag. 42	pinko ..... pag. 86	
	duplex ..... pag. 48	mini ..... pag. 88	
	spider ..... pag. 52	bell ..... pag. 92	
	round flat ..... pag. 56	polo ..... pag. 96	
	heavy ..... pag. 60	plane ..... pag. 98	
	square flat ..... pag. 64	basis ..... pag. 100	



## SYSTEMS

block ..... pag. 104

bridge ..... pag. 106

nevada ..... pag. 108

flexo A ..... pag. 114

flexo B ..... pag. 122

## corbetta

### CHAIRS

 pepper ..... pag. 138

 lexi ..... pag. 146

 celine ..... pag. 152

 afrodite ..... pag. 156

 cubica ..... pag. 160

 stripes ..... pag. 164

 jolie ..... pag. 168

 sorriso ..... pag. 172

fifty ..... pag. 176

diva ..... pag. 182

milena ..... pag. 186

pamela ..... pag. 190

charlie ..... pag. 194

geo ..... pag. 196

tree ..... pag. 198







# corbetta

**Dal 1958** le collezioni Corbetta Salvatore nascono per dare una risposta qualificata ed esaustiva al bisogno dei mercati internazionali di componenti e prodotti finiti per l'arredo, volti a soddisfare le nuove aspettative e necessità del mercato.

Ogni prodotto nasce sotto un'attenta analisi delle tendenze e richieste della clientela e viene sviluppato secondo un binomio che contraddistingue lo sviluppo di ogni prodotto: design e funzionalità.

La produzione interna spazia dalla lavorazione dell'acciaio a quella dell'alluminio, della plastica, del legno, garantendo la massima flessibilità all'azienda che permette di soddisfare le richieste di una clientela molto ampia, con gusti e necessità differenti.

Corbetta Salvatore offre la possibilità di realizzare prodotti unici e specifici per ogni singolo cliente grazie a personalizzazioni studiate da un attento gruppo di collaboratori aziendali che, mediante il loro bagaglio di esperienza e tradizione, trovano la soluzione giusta ad ogni tipo di richiesta.

***Since 1958**, the Corbetta Salvatore collections have been created to give a qualified and comprehensive response to the need of components international markets and furniture products, aiming to satisfy the new expectations and needs of HO.RE.CA market.*

*Each product is born under a careful trend analysis and customer request and it is developed according to a combination of design and functionality. Internal production goes from steel processing to aluminium, plastic and wood, ensuring maximum flexibility to match all requests with different tastes and needs.*

*Corbetta Salvatore offers the possibility to create an unique and specific product for any individual customer through customization and bespoke design. Our team, through their experience and skills, can find the right solution for every type of request.*

# 1958

**Il Signor Corbetta Salvatore con la moglie Rita fonda la Corbetta Salvatore Srl come azienda specializzata nella produzione di sedie, tavoli e accessori per il mobile a Cassago Brianza, in provincia di Lecco.**

**L'unità produttiva è di 500 mq. Da subito si rivolge ad un mercato nazionale ed Europeo affermandosi come produttore forte ed affidabile.**

*Mr Corbetta Salvatore and his wife Rita founded Corbetta Salvatore Srl as a company specialising in the production of chairs, tables and furniture accessories in Cassago Brianza, in the province of Lecco.*

*The production unit is 500 square metres. The company immediately addressed a national and European market, establishing itself as a strong and reliable producer.*



# 1961

**Partecipa al primo Salone del mobile di Milano, la prima di una lunga serie di fiere in Italia e all'estero che portano a far conoscere l'azienda a livello internazionale.**

*The company participates in the first Salone del Mobile in Milan, the first of a long series of fairs in Italy and abroad that lead to make the company known internationally.*



# 1979

**La produzione si amplia ulteriormente nella nuova sede di Molteno. L'unità produttiva è di 4000 mq.**

*Production is further expanded at the new site in Molteno. The production unit covers 4000 square metres.*

# 1990

**Con l'entrata in azienda del genero Alfio Valnegri l'azienda espande i propri orizzonti commerciali verso il nascente mercato del DIY. Con i suoi accessori diventa azienda di riferimento per gran parte delle catene negozi nazionali ed internazionali sul mercato Italiano.**

*When son-in-law Alfio Valnegri joined the company, it expanded its commercial horizons towards the emerging DIY market. With its accessories it became a reference company for most of the national and international chain shops on the Italian market.*





# corbetta



1999

La sede di Molteno si amplia ancora fino a raggiungere l'attuale superficie di oltre 16000 mq.

*The Molteno site is expanded to its current size of over 16,000 square metres.*



2007

Con l'acquisto dei prodotti e del marchio Ego Project si afferma sul mercato internazionale degli accessori per interno armadio

*With the purchase of the Ego Project products and brand, the company established itself on the international market for interior fittings.*



2008

Dal 2008 la proprietà investe in tecnologia dotandosi di macchine per la produzione, sempre più performanti e innovative. Inizia così lo sviluppo tecnologico dell'azienda che punta ad affermarsi sempre di più nel settore arredo-contract, realizzando negli anni una vasta gamma di prodotti per questo mercato ormai divenuto mondiale.

*Since 2008, the owners have been investing in technology, equipping themselves with increasingly high performance and innovative production machines. This is the beginning of the technological development of the company that aims to establish itself more and more in the furniture-contract sector, creating over the years a wide range of products for this market that has become worldwide.*

2012

La gestione passa alla terza generazione. Una storia di famiglia che guarda al valore della tradizione con lo sguardo volto al futuro. Inizia parallelamente un percorso di sostenibilità dei prodotti e di ottimizzazione delle risorse ed energia. Macchinari sempre più all'avanguardia ma dai consumi ridotti, ottimizzazione packaging e logistica, riciclo e Sistema Qualità Certificato garantiscono la massima sostenibilità per prodotti e ambiente.

*The management passes to the third generation. A family history that looks to the value of tradition with an eye to the future. At the same time, a path of product sustainability and optimisation of resources and energy begins. Cutting-edge machinery with reduced consumption, optimised packaging and logistics, recycling and a certified quality system guarantee maximum sustainability for products and the environment.*



corbetta

TABLE BASES

2022

corbetta



*mondrian*

TABLE





## corbetta

### PIANO TAVOLO / TABLE TOP

laminato/laminate 24 mm pag. 204  
bordo/edge ABS

hpl \*OUTDOOR USE ☁️ 10-12 mm pag. 206

include fori per il drenaggio dell'acqua e una fessura centrale sul piano per l'appoggio di smartphone e tablet e foro da 34mm per l'ombrello  
*Water draining holes, central slot for smartphones and tablets and 34mm central hole for umbrella are included*

### PIEDE / FOOT

FISSAGGIO A TERRA / FLOOR FIXING

acciaio/steel

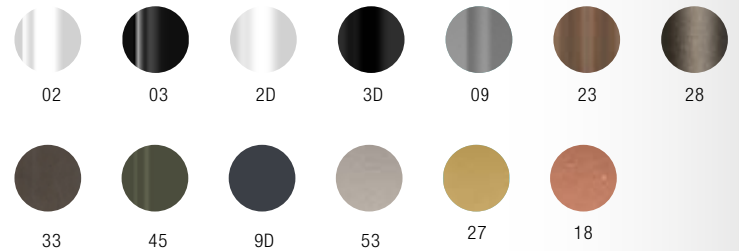

acciaio inox/stainless steel

\*OUTDOOR USE ☁️

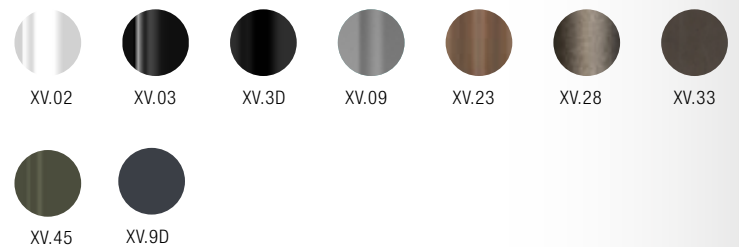

# mondrian

## TABLE



BT.600

Laminato / Laminate HPL  
 H<sup>1</sup>: 73,5 cm H<sup>2</sup>: 47,5 cm H<sup>1</sup>: 72 cm H<sup>2</sup>: 46 cm

TOP:	80 x 80 cm	TOT:	160 x 80 cm
	80 x 120 cm		160 x 120 cm
	80 x 140 cm		160 x 140 cm
	80 x 160 cm		160 x 160 cm
	80 x 180 cm		160 x 180 cm



BT.605

Laminato / Laminate HPL  
 H<sup>1</sup>: 109,5 cm H<sup>2</sup>: 77,5 cm H<sup>1</sup>: 108 cm H<sup>2</sup>: 76 cm

TOP:	80 x 120 cm	TOT:	160 x 120 cm
	80 x 140 cm		160 x 140 cm
	80 x 160 cm		160 x 160 cm
	80 x 180 cm		160 x 180 cm



BT.607

Laminato / Laminate HPL  
 H<sup>1</sup>: 109,5 cm H<sup>2</sup>: 77,5 cm H<sup>1</sup>: 108 cm H<sup>2</sup>: 76 cm

TOP:	44 x 120 cm	TOT:	84 x 120 cm
	44 x 140 cm		84 x 140 cm
	44 x 160 cm		84 x 160 cm
	44 x 180 cm		84 x 180 cm

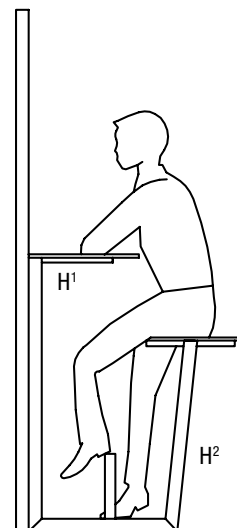
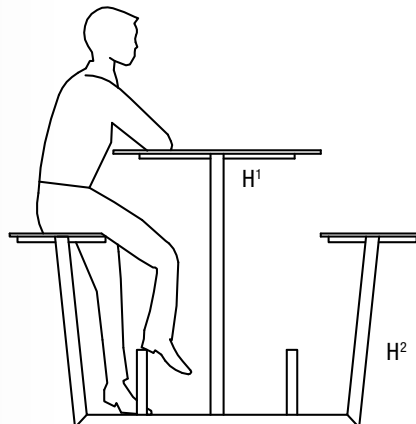
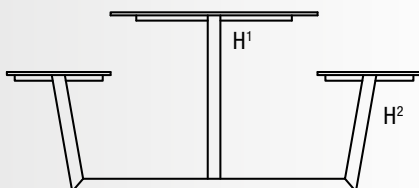



**corbetta**



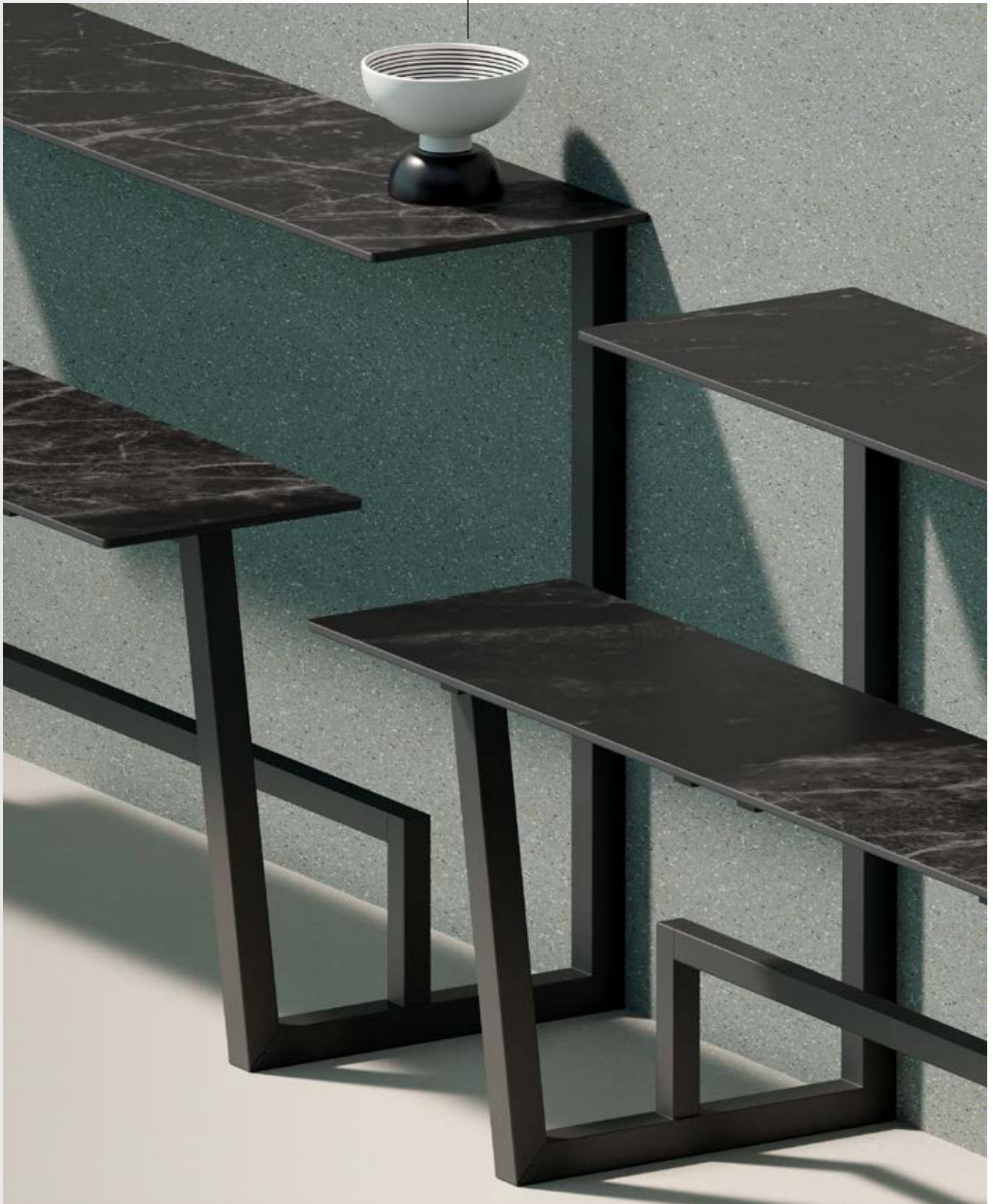

corbetta



madrid

TABLE





## corbetta

### PIANO TAVOLO / TABLE TOP

laminato/laminate  
bordo/edge ABS

24 mm

pag. 204

hpl \*OUTDOOR USE 

include foro da 34mm per l'ombrellone  
*Central hole for umbrella is included*

10-12 mm

pag. 206

### PIEDE / FOOT

acciaio/steel

FISSAGGIO A TERRA / FLOOR FIXING



02



03



2D



3D



09



23



28



33



45



9D



53



27



18

acciaio inox/stainless steel

\*OUTDOOR USE 



XV.02



XV.03



XV.3D



XV.09



XV.23



XV.28



XV.33



XV.45



XV.9D

madrid

TABLE



BT.609

Laminato / Laminate HPL  
H<sup>1</sup>: 73,5 cm H<sup>2</sup>: 47,5 cm H<sup>1</sup>: 72 cm H<sup>2</sup>: 46 cm

TOP: ø 110 cm

TOT: ø 180 cm

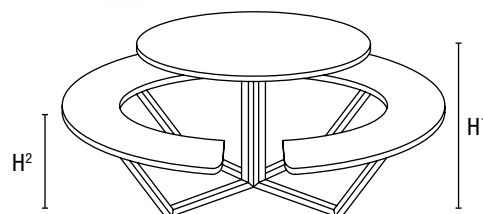

corbetta



*matias*

TABLE





## corbetta

### PIANO TAVOLO / TABLE TOP

laminato/laminate 24 mm pag. 204  
bordo/edge ABS

hpl \*OUTDOOR USE  10-12 mm pag. 206  
include fessure per il drenaggio dell'acqua e foro da 34mm per l'ombrellone  
*Water draining hole and 34mm central hole for umbrella are included*

### PIEDE / FOOT

FISSAGGIO A TERRA / FLOOR FIXING

acciaio/steel

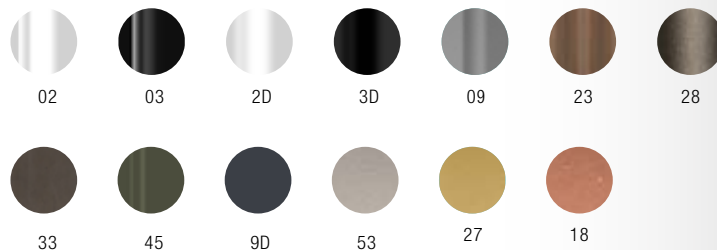

acciaio inox/stainless steel

\*OUTDOOR USE 





# matias

TABLE



BT.601

Laminato / Laminate      HPL  
H<sup>1</sup>: 73,5 cm H<sup>2</sup>: 46 cm      H<sup>1</sup>: 72 cm H<sup>2</sup>: 44 cm

TOP:	80 x 120 cm	BENCH:	40 x 105 cm
	80 x 140 cm		40 x 125 cm
	80 x 160 cm		40 x 145 cm
	80 x 180 cm		40 x 165 cm

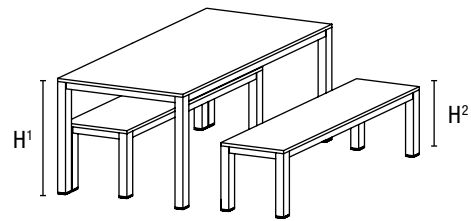

**corbetta**



tetris

TABLE BASE





## corbetta

### PIANO TAVOLO / TABLE TOP

legno/wood	pag. 214
melaminico/melamine	pag. 202
laminato/laminate	pag. 204
hpl	pag. 206
vetro/glass	

### PIEDE / FOOT

#### acciaio/steel

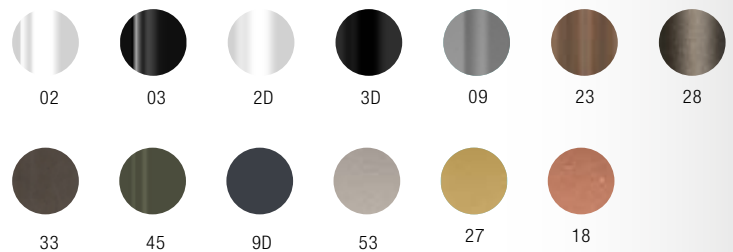

#### acciaio inox/stainless steel

\*OUTDOOR USE 



# tetris

## TABLE BASE



REGOLABILE / ADJUSTABLE 

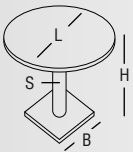

### BT.193

L. Ø 90 - 80x80 cm <b>max</b> h.43/73	B. Ø 58 cm
L. Ø 80 - 70x70 cm <b>max</b> h.107	
H. 43/73/107 cm	S. Ø 6 cm

### BT.194

L. Ø110-90x90 cm <b>max</b> h.73	B. Ø 70 cm
L. Ø 90 - 80x80 cm <b>max</b> h.107	
H. 73/107 cm	S. Ø 8 cm



REGOLABILE / ADJUSTABLE 

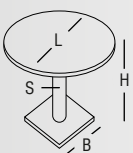

### BT.195.070

L. 90x140 cm <b>max</b>	B. 58x82 cm
H. 73 cm	S. Ø 6 cm

### BT.195.100

L. 90x160 cm <b>max</b>	B. 58x107 cm
H. 73 cm	S. Ø 6 cm

### BT.195.120

L. 90x180 cm <b>max</b>	B. 58x127 cm
H. 73 cm	S. Ø 6 cm

corbetta





petal  
TABLE BASE



## corbetta

### PIANO TAVOLO / TABLE TOP

legno/wood	pag. 214
melaminico/melamine	pag. 202
laminato/laminate	pag. 204
hpl	pag. 206
vetro/glass	

### PIEDE / FOOT

#### acciaio/steel

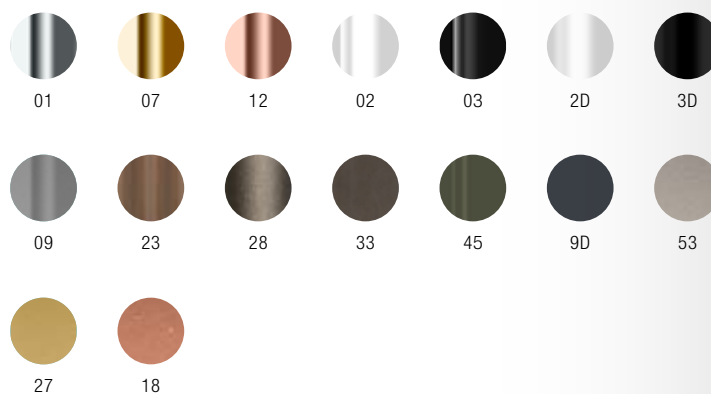



# petal

## TABLE BASE



BT.186

L. Ø 70 cm <b>max</b> h.43/73	B. Ø 58 cm
L. Ø 60 cm <b>max</b> h.107	
H. 43/73/107 cm	S. Ø 6 cm



BT.185

L. Ø 90 - 80x80 cm <b>max</b> h.43/73	B. Ø 58 cm
L. Ø 80 - 70x70 cm <b>max</b> h.107	
H. 43/73/107 cm	S. Ø 6 cm

REGOLABILE / ADJUSTABLE

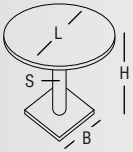







**corbetta**

# petal

## TABLE BASE



REGOLABILE / ADJUSTABLE 

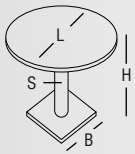

BT.189.070

<b>L. max</b>	90 x 140	<b>B.</b>	58 x 85 cm
<b>H.</b>	73 cm	<b>S.</b>	Ø 6 cm

BT.189.100

<b>L. max</b>	90 x 160	<b>B.</b>	58 x 115 cm
<b>H.</b>	73 cm	<b>S.</b>	Ø 6 cm

BT.189.120

<b>L. max</b>	90 x 180	<b>B.</b>	58 x 135 cm
<b>H.</b>	73 cm	<b>S.</b>	Ø 6 cm



**corbetta**



petal big one

TABLE BASE





## corbetta

### PIANO TAVOLO / TABLE TOP

legno/wood	pag. 214
melaminico/melamine	pag. 202
laminato/laminate	pag. 204
hpl	pag. 206
vetro/glass	

### PIEDE / FOOT

#### acciaio/steel

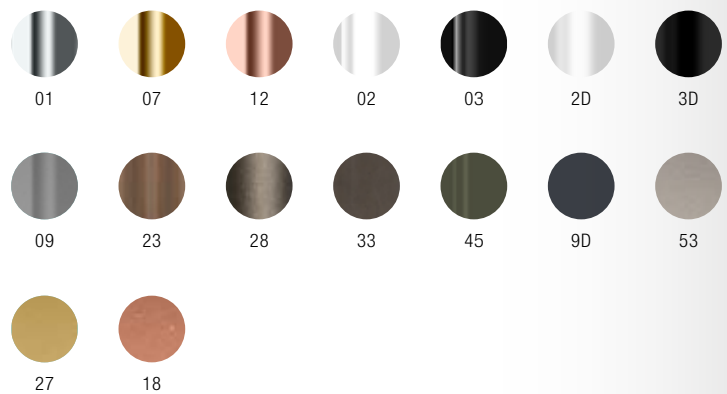



# petal big one

TABLE BASE



REGOLABILE / ADJUSTABLE 

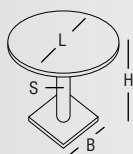

BT.230

L. Ø 110 cm <b>max</b>	B. Ø 70 cm
H. 73/107 cm	S. Ø 10 cm





**corbetta**



*petal big four*

TABLE BASE



## corbetta

### PIANO TAVOLO / TABLE TOP

legno/wood	pag. 214
melaminico/melamine	pag. 202
laminato/laminate	pag. 204
hpl	pag. 206

### PIEDE / FOOT

#### acciaio/steel

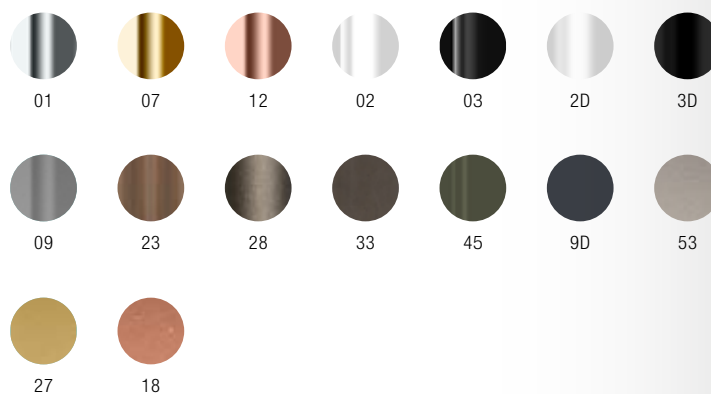

# petal big four

TABLE BASE



REGOLABILE / ADJUSTABLE 

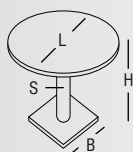

BT.234

L. Ø 200 cm **max**  
h.73

L. Ø 160 cm **max**  
h.107

H. 73/107 cm

B. Ø 70 cm

S. Ø 8 cm





**corbetta**



corbetta





*duplex*<sup>round/petal</sup>

TABLE BASE





## corbetta

### PIANO TAVOLO / TABLE TOP

legno/wood	pag. 214
melaminico/melamine	pag. 202
laminato/laminate	pag. 204
hpl	pag. 206

### PIEDE / FOOT

#### acciaio/steel

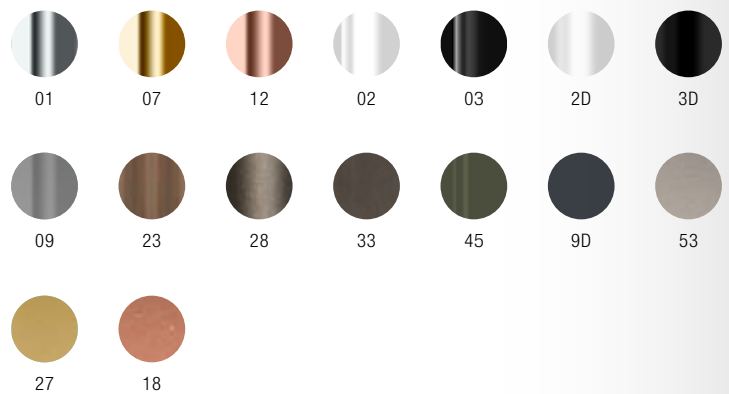

# duplex<sup>round/petal</sup>

## TABLE BASE



BT.241

L. Ø 90 - 80x80 cm <b>max</b> h. 73	B. Ø 58 cm
L. Ø 80 - 70x70 cm <b>max</b> h.107	
H. 73/107 cm	S. Ø 6 cm



BT.240

L. Ø 90 - 80x80 cm <b>max</b> h.43/73	B. Ø 44 cm
L. Ø 80 - 70x70 cm <b>max</b> h.107	
H. 73/107 cm	S. Ø 6 cm

REGOLABILE / ADJUSTABLE

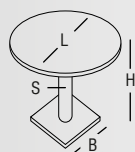

**corbetta**



spider

TABLE BASE





## corbetta

### PIANO TAVOLO / TABLE TOP

legno/wood	pag. 214
melaminico/melamine	pag. 202
laminato/laminate	pag. 204
hpl	pag. 206

### PIEDE / FOOT

#### acciaio/steel

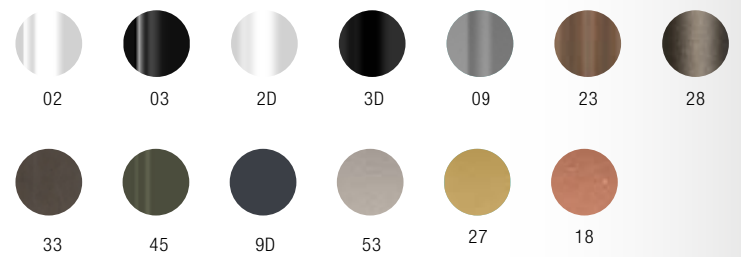

#### acciaio inox/stainless steel

\*OUTDOOR USE 



# spider

TABLE BASE



REGOLABILE / ADJUSTABLE

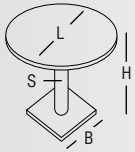

BT.155.43

L. Ø 70-60x60 cm <b>min</b>	B. 53 x 53 cm
H. 43 cm	S. 5 x 5 cm

BT.155.73

L. Ø 90-70x70 cm <b>min</b>	B. 68 x 68 cm
H. 73 cm	S. 5 x 5 cm

BT.155.107

L. Ø 70-60x60 cm <b>min</b>	B. 53 x 53 cm
H. 107 cm	S. 5 x 5 cm





corbetta



A photograph of a modern dining table and chairs. The table is round with a dark, marbled top and a single copper-colored leg. The chairs are black with silver metal frames. The floor is a light-colored terrazzo with colorful speckles. The text 'round' is centered in the upper half of the image, and 'TABLE BASE' is centered below it.

round

TABLE BASE



## corbetta

### PIANO TAVOLO / TABLE TOP

legno/wood	pag. 214
melaminico/melamine	pag. 202
laminato/laminate	pag. 204
hpl	pag. 206
vetro/glass	

### PIEDE / FOOT

#### acciaio/steel

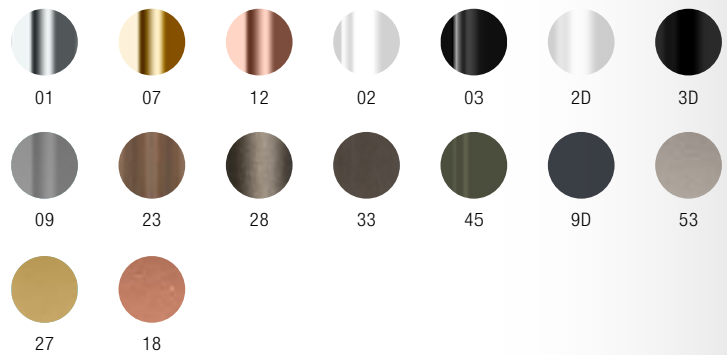

#### acciaio inox/stainless steel

\*OUTDOOR USE ☁️

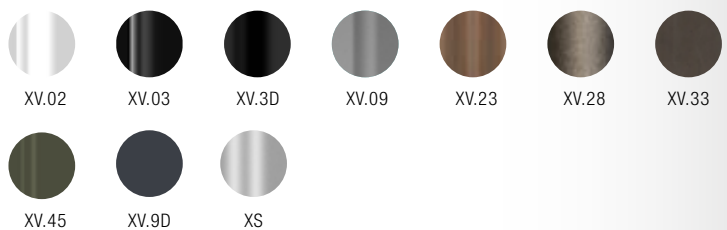

round

TABLE BASE



BT.108

L. Ø 90 - 80x80 cm <b>max</b> h.43/73	B. Ø 44 cm
L. Ø 80 - 70x70 cm <b>max</b> h.107	
H. 43/73/107 cm	S. Ø 6 cm

REGOLABILE / ADJUSTABLE 

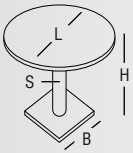

BT.105

L. Ø 90 - 80x80 cm <b>max</b> h.43/73	B. Ø 44 cm
L. Ø 80 - 70x70 cm <b>max</b> h.107	
H. 43/73/107 cm	S. Ø 8 cm

REGOLABILE / ADJUSTABLE 

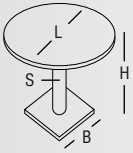

BT.109

L. Ø 120 - 100x100 cm <b>max</b> h.73	B. Ø 60 cm
L. Ø 100 - 80x80 cm <b>max</b> h.107	
H. 73/107 cm	S. Ø 8 cm



corbetto

heavy

TABLE BASE





## corbetta

### PIANO TAVOLO / TABLE TOP

legno/wood	pag. 214
melaminico/melamine	pag. 202
laminato/laminate	pag. 204
hpl	pag. 206
vetro/glasss [solo Heavy 1]	

### PIEDE / FOOT

#### acciaio/steel

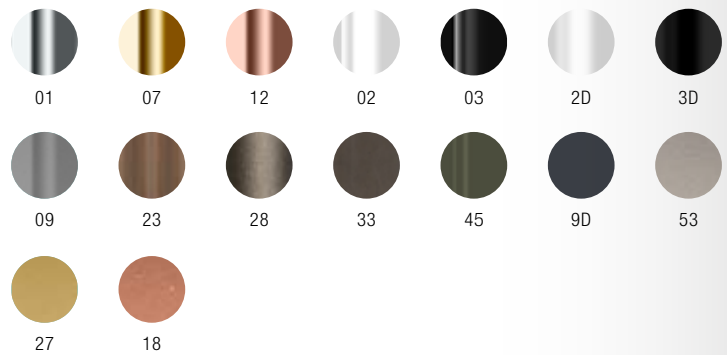

#### acciaio inox/stainless steel

\*OUTDOOR USE ☁️

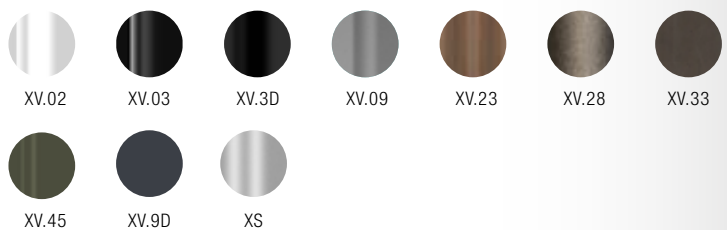

# heavy

## TABLE BASE



BT.107

L. Ø 140 - 100x100 cm <b>max</b> h.73	B. Ø 70 cm
L. Ø 110 - 80x80 cm <b>max</b> h.107	
H. 73/107 cm	S. Ø 10 cm

REGOLABILE / ADJUSTABLE 

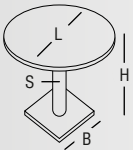

BT.110

L. Ø 200 cm <b>max</b> h.73	B. Ø 70 cm
L. Ø 160 cm <b>max</b> h.107	
H. 73/107 cm	S. Ø 8 cm



BT.111

L. Ø 160 cm <b>max</b> h.73	B. Ø 70 cm
L. Ø 120 cm <b>max</b> h.107	
H. 73/107 cm	S. Ø 8 cm

REGOLABILE / ADJUSTABLE 

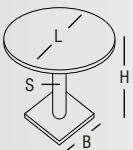

**corbetta**





square

CHAIRS





## corbetta

### PIANO TAVOLO / TABLE TOP

legno/wood	pag. 214
melaminico/melamine	pag. 202
laminato/laminate	pag. 204
hpl	pag. 206
vetro/glass	

### PIEDE / FOOT

#### acciaio/steel

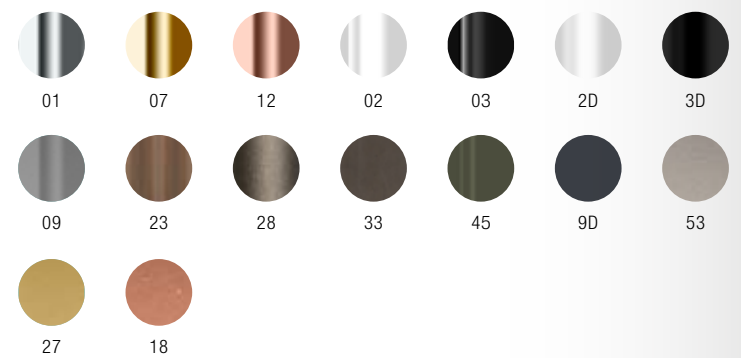

#### acciaio inox/stainless steel

\*OUTDOOR USE ☁️

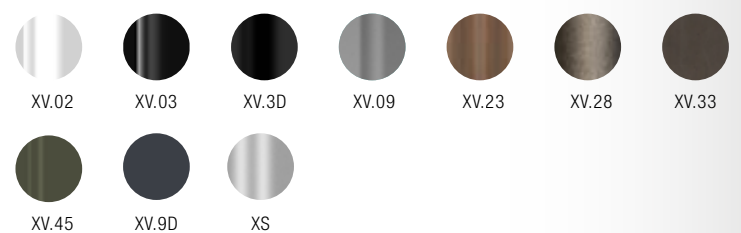

# square

## TABLE BASE



L. B S H

REGOLABILE / ADJUSTABLE

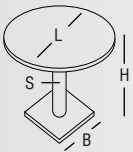

BT.112			6x6 cm	
BT.113	Ø 90 - 80x80 cm <b>max</b> h.43/73		8x8 cm	
BT.118	Ø 80 - 70x70 cm <b>max</b>		Ø 6 cm	
BT.125	h.107	40x40 cm	Ø 8 cm	43/73/107 cm
BT.114	Ø 110 - 90x90 cm <b>max</b> h.43/73		8x8 cm	
BT.126	Ø 90 - 80x80 cm <b>max</b> h.107	50x50 cm	Ø 8 cm	73/107 cm
BT.146	Ø 120 - 100x100 cm <b>max</b> h.73		8x8 cm	
BT.148	Ø 100 - 90x90 cm <b>max</b> h.107	60x60 cm	Ø 8 cm	73/107 cm
BT.225	80x100 cm <b>max</b> h.73	40x60 cm	8x8 cm	73 cm
BT.120	80x160 cm <b>max</b> h.43/73		2 x 6x6 cm	
BT.124	80x120 cm <b>max</b> h.107	40x80 cm	2 x Ø 6 cm	43/73/107 cm
BT.121	90x160 cm <b>max</b> h.73		2 x 8x8 cm	
BT.127	90x120 cm <b>max</b> h.107	40x80 cm	2 x Ø 8 cm	73/107 cm

corbetta



*rubik*

TABLE BASE





## corbetta

### PIANO TAVOLO / TABLE TOP

legno/wood	pag. 214
melaminico/melamine	pag. 202
laminato/laminate	pag. 204
hpl	pag. 206

### PIEDE / FOOT

acciaio/steel

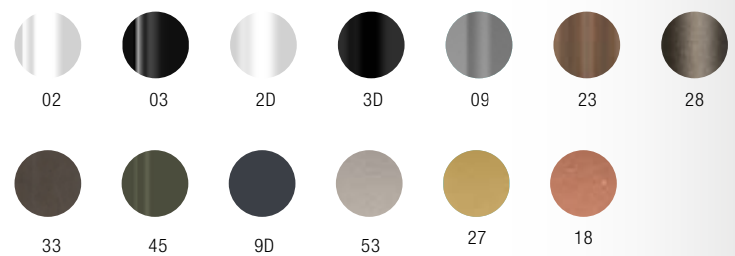

*rubik*

TABLE BASE

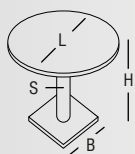

BT.198

L. 100x100 cm **max**  
h.43/73

B. 51x51 cm

L. 90x90 cm **max**  
h.107

H. 43/73/107 cm

S. 25x25 cm





## corbetta

### PIANO TAVOLO / TABLE TOP

legno/wood	pag. 214
melaminico/melamine	pag. 202
laminato/laminate	pag. 204
hpl	pag. 206
vetro/glass	

### PIEDE / FOOT

acciaio/steel

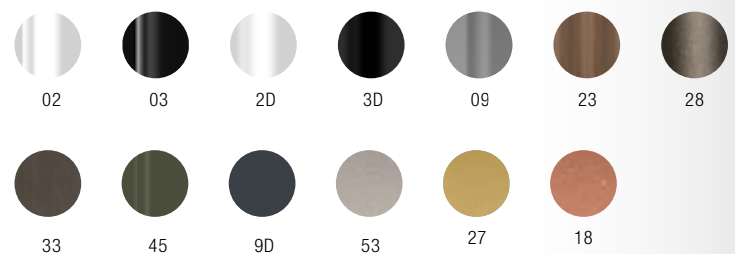



# bomb

## TABLE BASE



BT.116

L.	Ø 90 - 80x80 cm max h.43/73	B.	44 cm
L.	Ø 80-70x70 cm max h.107		
H.	43/73/107 cm	S.	Ø 8 cm



BT.117

L.	Ø 100 - 90x90 cm max h.43/73	B.	60 cm
L.	Ø 90-80x80 cm max h.107		
H.	73/107 cm	S.	Ø 8 cm

REGOLABILE / ADJUSTABLE

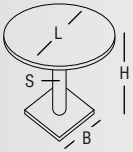



## corbetta

### PIANO TAVOLO / TABLE TOP

legno/wood pag. 214

melaminico/melamine pag. 202

laminato/laminate pag. 204

### PIEDE / FOOT

acciaio/steel

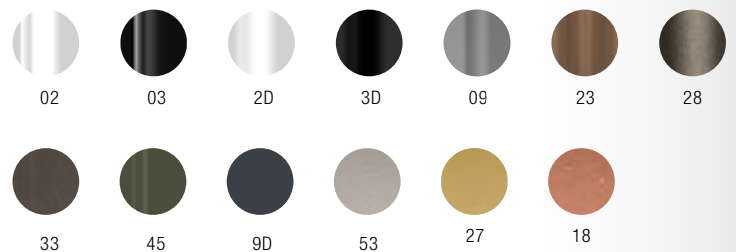

cono

TABLE BASE + STOOL



REGOLABILE / ADJUSTABLE

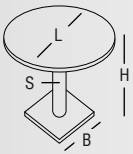

BT.520

L.	Ø 90 cm <b>max</b> h.73	B.	44 cm
L.	Ø 80 <b>max</b> h.107	S.	single cone
H.	73/107 cm		

BT.521

L.	90x160 cm <b>max</b> h.73	B.	40 x 80 cm
L.	90x120 <b>max</b> h.107	S.	double cone
H.	73/107 cm		

SE.1069

L.	44 cm	P.	44 cm
H.	75 cm	S.	75 cm



corbetta



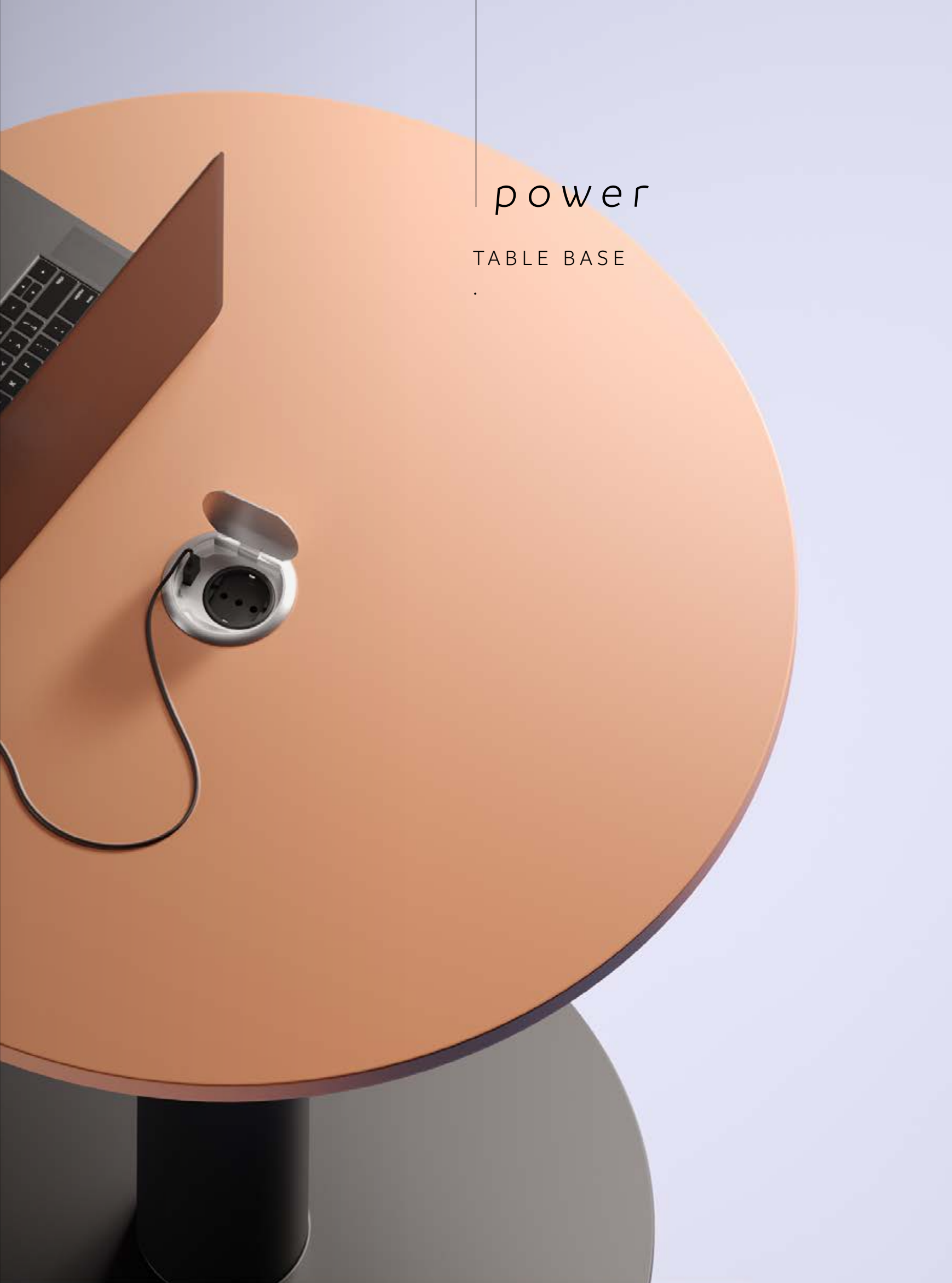

power

TABLE BASE



## corbetta

### PIANO TAVOLO / TABLE TOP

legno/wood	pag. 214
melaminico/melamine	pag. 202
laminato/laminate	pag. 204
hpl	pag. 206

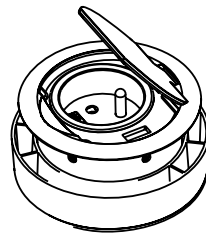

### POWER DEVICE

usb + schuko  
BT.270.D1.14

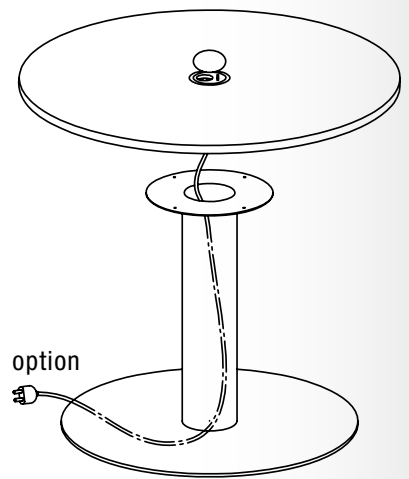

### PIEDE / FOOT

acciaio/steel

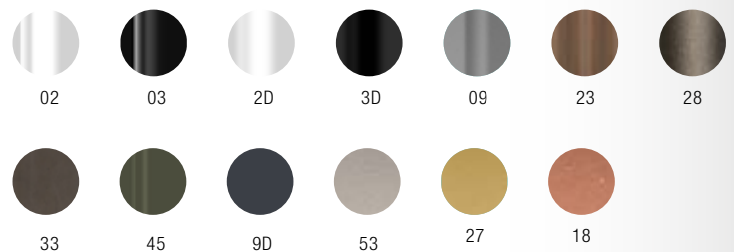

power

TABLE BASE



REGOLABILE / ADJUSTABLE 

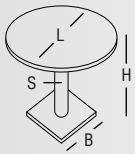

BT.269

L.	h.73 Ø 100 cm <b>max</b>	B.	Ø 44 cm
L.	h.107 Ø 80 cm <b>max</b>		
H.	73/107 cm	S.	Ø 14 cm

BT.270

L.	h.73 Ø 130 cm <b>max</b>	B.	Ø 70 cm
L.	h.107 Ø 110 cm <b>max</b>		
H.	73/107 cm	S.	Ø 14 cm

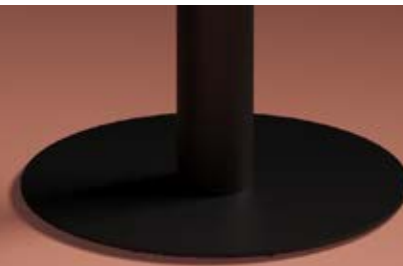

corbetta





kora

TABLE BASE



## corbetta

### PIANO TAVOLO / TABLE TOP

legno/wood	pag. 214
melaminico/melamine	pag. 202
laminato/laminate	pag. 204
hpl	pag. 206

### PIEDE / FOOT

acciaio/steel

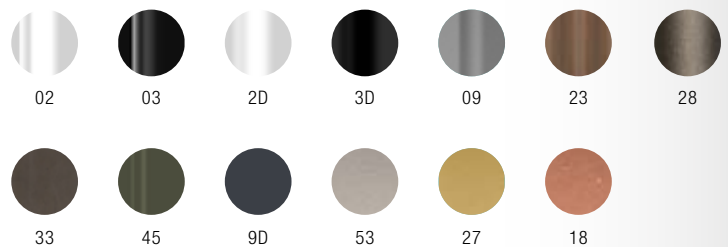

kora

TABLE BASE



BT.257

L. Ø 70 cm <b>max</b>	B. Ø 60 cm
H. 100 cm	S. Ø 1.6 cm

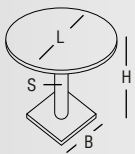



## corbetta

### PIANO TAVOLO / TABLE TOP

legno/wood pag. 214

melaminico/melamine pag. 202

laminato/laminate pag. 204

hpl pag. 206

MAX 8 KG TOP

### PIEDE / FOOT

acciaio/steel



01

*lift*

TABLE BASE



BT.130.48

BT.130.73

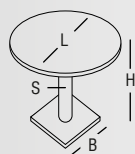

L. Ø 80 cm **max**

B. Ø 47 cm

H. 48/73 cm

S. Ø 8 cm

L. Ø 80 cm **max**

B. Ø 47 cm

H. 73/109 cm

S. Ø 8 cm





## corbetta

### PIANO TAVOLO / TABLE TOP

legno/wood

pag. 214

melaminico/melamine

pag. 202

laminato/laminate

pag. 204

hpl [solo PINKO BIG]

\*

REGOLABILE / ADJUSTABLE



solo/only PINKO BIG

il PINKO MINI ha il puntale fisso

the PINKO MINI has a fixed tip

### PIEDE / FOOT

acciaio/steel



01



02



03



2D



3D



09



23



28



33



45



9D



53



27



18

pinko

TABLE BASE



BT.255 \*

L. $\emptyset$ 90 - 80x80 cm max h.73	B. 60 cm
L. $\emptyset$ 80-70x70 cm max h.107	
H. 73/107 cm	S. $\emptyset$ 2.5 cm



BT.250

L. $\emptyset$ 40 cm max	B. $\emptyset$ 35 cm
H. 43 cm	S. $\emptyset$ 1.6 cm

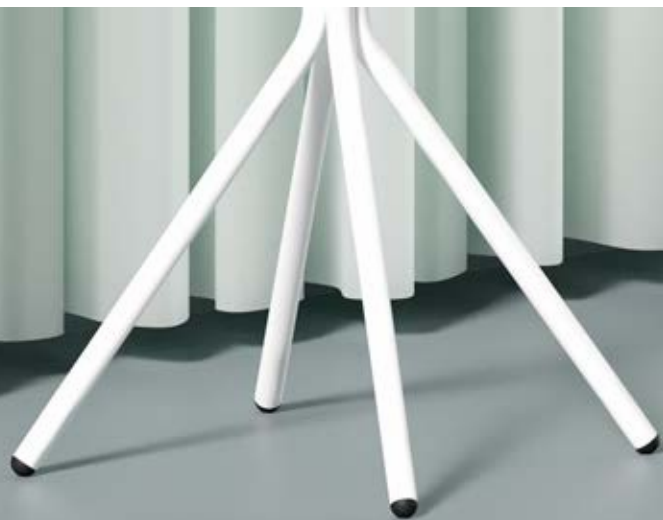
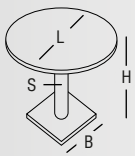

corbetta





*mini* flat

TABLE BASE



## corbetta

### PIANO TAVOLO / TABLE TOP

legno/wood	pag. 214
melaminico/melamine	pag. 202
laminato/laminate	pag. 204
hpl	pag. 206

### PIEDE / FOOT

acciaio/steel

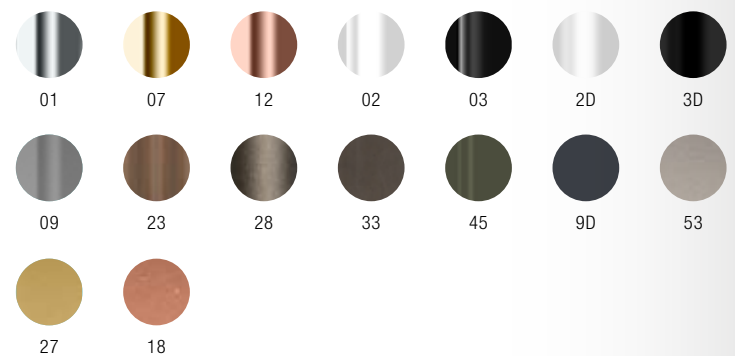

*mini flat*

TABLE BASE



BT.259.L

L.	Ø 50 cm <b>max</b> 40x40 cm <b>max</b>	B.	Ø 30 cm
H.	43/73 cm	S.	Ø 5 cm

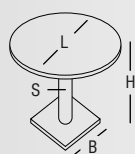

corbetto



bell round/square

table base

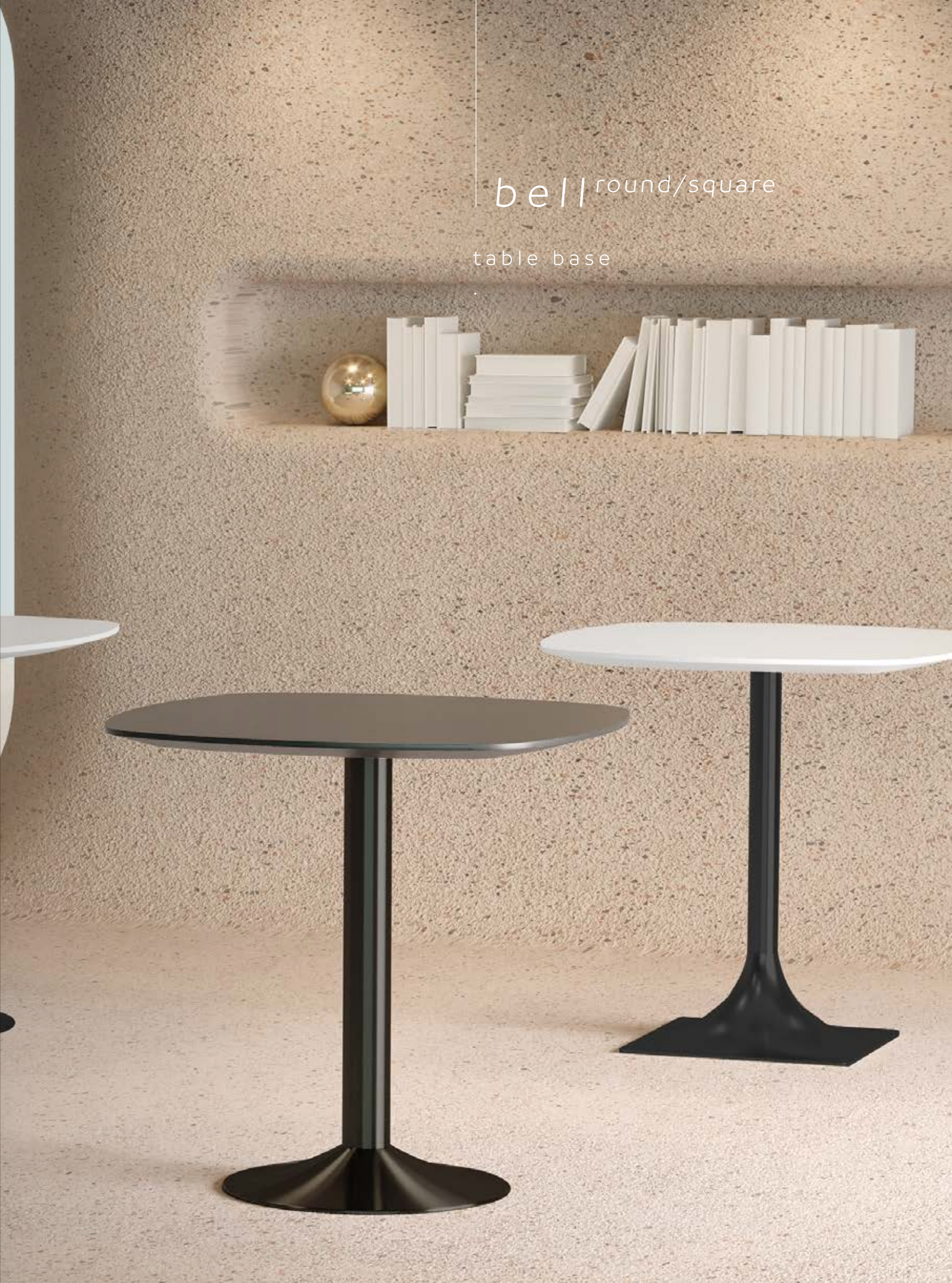



## corbetta

### PIANO TAVOLO / TABLE TOP

legno/wood	pag. 214
melaminico/melamine	pag. 202
laminato/laminate	pag. 204
hpl	pag. 206

### PIEDE / FOOT

acciaio/steel

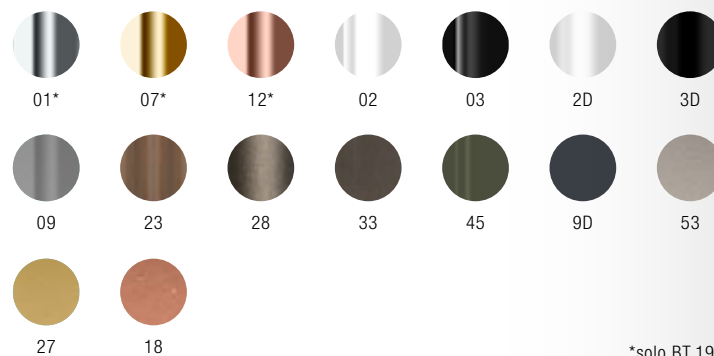

\*solo BT.190

bell<sup>round/square</sup>

TABLE BASE

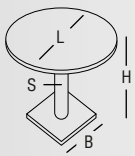

BT.190

L.	Ø 90 - 80x80 cm <b>max</b> h.43/73	B.	Ø 48 cm
L.	Ø 80 - 70x70 cm <b>max</b> h.107		
H.	73/107 cm	S.	Ø 8 cm

BT.191

L.	Ø 100 - 90x90 cm <b>max</b> h.43/73	B.	45x45 cm
L.	Ø 90 - 70x70 cm <b>max</b> h.107		
H.	73/107 cm	S.	Ø 6 cm



















## corbetta

### PIANO TAVOLO / TABLE TOP

legno/wood	pag. 214
melaminico/melamine	pag. 202
laminato/laminate	pag. 204
hpl	pag. 206

### PIEDE / FOOT

#### acciaio/steel

						
01	02	03	2D	3D	09	23
						
28	33	45	9D	53	27	18



polo<sup>4/3</sup>

TABLE BASE



REGOLABILE / ADJUSTABLE 

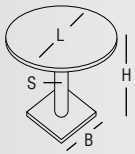

BT.151

L.	Ø 80 - 70x70 cm <b>max</b> h.73	B. Ø 58 cm
L.	Ø 70 - 60x60 cm <b>max</b> h.107	
H.	73/107 cm	S. Ø 5 cm

BT.150

L.	Ø 70 cm <b>max</b> h.73	B. Ø 58 cm
H.	73 cm	S. Ø 5 cm





## corbetta

### PIANO TAVOLO / TABLE TOP

legno/wood	pag. 214
melaminico/melamine	pag. 202
laminato/laminate	pag. 204
hpl	pag. 206

### PIEDE / FOOT

acciaio/steel

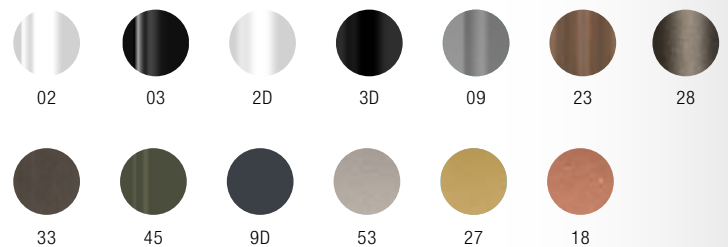

# plane<sup>round/square</sup>

## TABLE BASE



REGOLABILE / ADJUSTABLE 

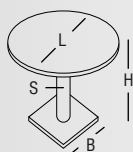

BT.170

L.	Ø 90 - 80x80 cm <b>max</b> h.73	B.	Ø 44 cm
L.	Ø 80 - 70x70 cm <b>max</b> h.107		
H.	73/107 cm	S.	Ø 8 cm

BT.171

L.	Ø 100 - 90x90 cm <b>max</b> h.73	B.	47 x 47 cm
L.	Ø 90 - 80x80 cm <b>max</b> h.107		
H.	73/107 cm	S.	8 x 8 cm





## corbetta

### PIANO TAVOLO / TABLE TOP

legno/wood	pag. 214
melaminico/melamine	pag. 202
laminato/laminate	pag. 204
hpl	pag. 206

### PIEDE / FOOT

acciaio/steel

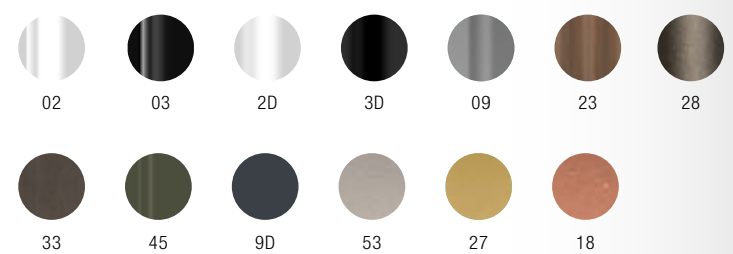

# basis <sup>3/4</sup>

## TABLE BASE



REGOLABILE / ADJUSTABLE 

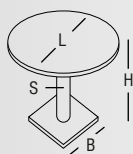

BT.153

L.	Ø 80 - 70x70 cm <b>max</b> h.73	B.	Ø 60 cm
H.	73 cm	S.	Ø 30 cm

BT.152

L.	Ø 90 - 80x80 cm <b>max</b> h.73	B.	Ø 60 cm
H.	73 cm	S.	Ø 30 cm







corbetta

FLEXO

2022

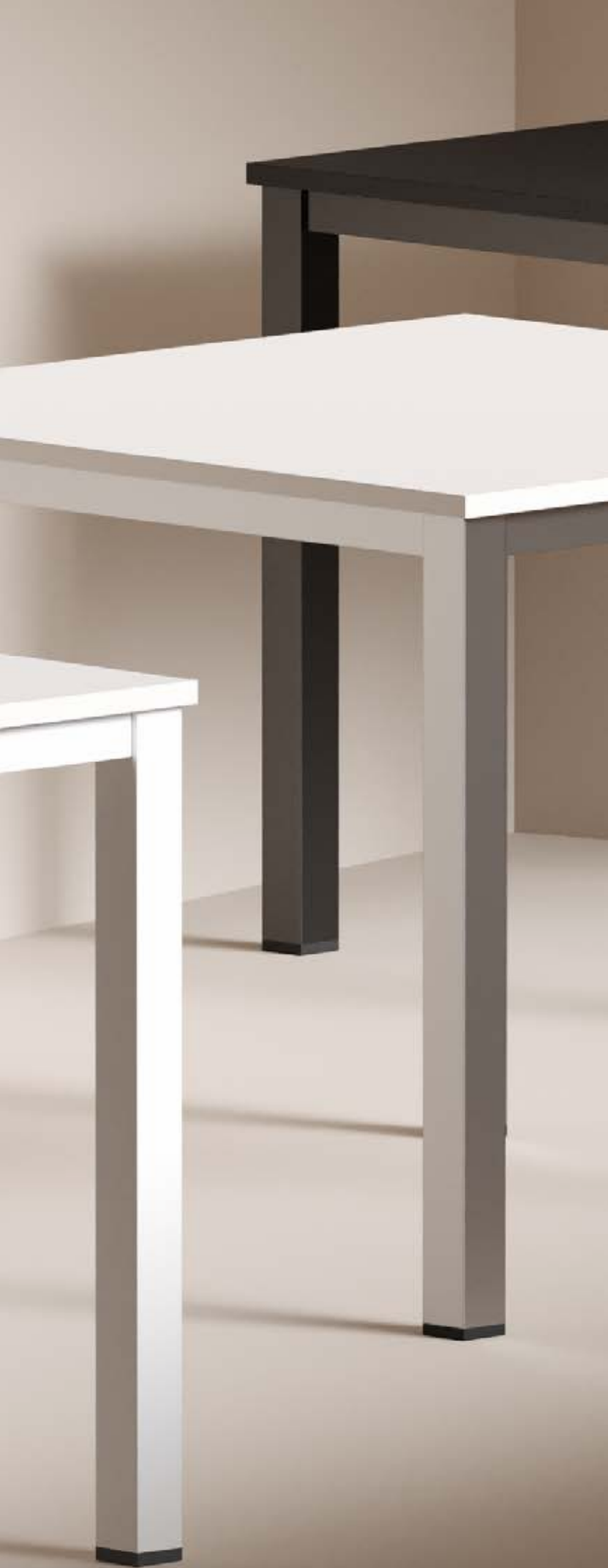

## corbetta

### SISTEMA MODULARE / MODULAR SYSTEM

Sistema modulare con giunti per costruire strutture per tavoli.  
Le strutture sono costruite con tubi d'acciaio a sezione quadrata.  
La componibilità della struttura permette di costruire tavoli  
in diverse dimensioni ed altezze. Tutte le gambe sono dotate di regolabile.

*Modular system with connection joints to build tables structure formed by square section steel tubes. The modular system allows to build tables in different sizes and heights. All legs are equipped with adjusters.*

### OPZIONALE / OPTIONAL



CON RUOTE / WITH WHEELS

REGOLABILE / ADJUSTABLE 

### PIEDE / FOOT acciaio/steel

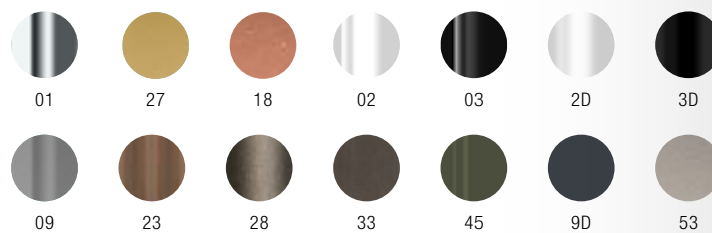

### acciaio inox/stainless steel

\*OUTDOOR USE 

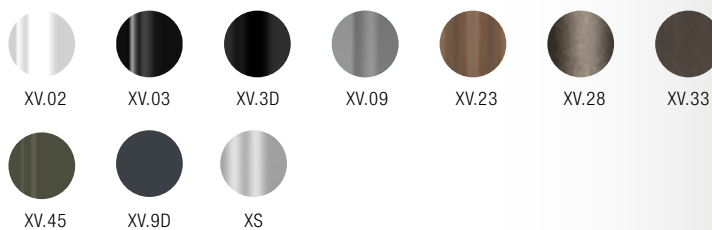



# block

## TABLE BASE



GAMBE / LEGS / PIEDS - 2 way  
50x50 mm - Set 4 pcs

**BT200.038L** H. 38 cm  
**BT200.071L** H. 71 cm  
**BT200.107L** H. 107 cm

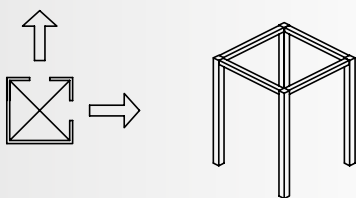
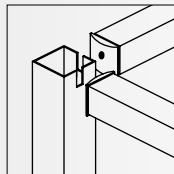

GAMBE / LEGS / PIEDS - 3 way  
50x50 mm - Set 2 pcs

**BT201.071L** H. 71 cm  
**BT201.107L** H. 107 cm

\*\* Per tavoli con lato superiore a 240 cm  
\*\* For tables with side up to 240 cm

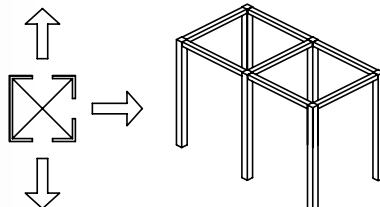
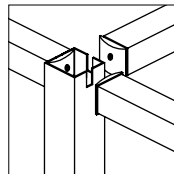

TRAVERSE / CROSSBARS / TRAVERSES  
40x40 mm - Set 2 pcs

**BT203.048L** 60 lato/side - cm  
**BT203.058L** 70  
**BT203.068L** 80  
**BT203.078L** 90  
**BT203.088L** 100  
**BT203.108L** 120  
**BT203.128L** 140  
**BT203.148L** 160  
**BT203.168L** 180  
**BT203.188L** 200  
**BT203.208L** 220  
**BT203.228L** 240

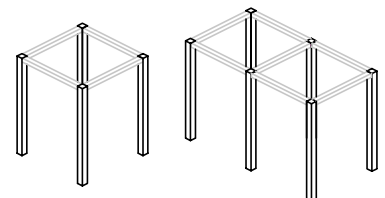



## corbetta

### SISTEMA MODULARE / MODULAR SYSTEM

Sistema modulare con giunti per costruire strutture per tavoli.  
Le strutture sono costruite con tubi d'acciaio a sezione quadrata.  
La componibilità della struttura permette di costruire tavoli  
in diverse dimensioni ed altezze. Tutte le gambe sono dotate di regolabile.

*Modular system with connection joints to build tables structure formed by square section steel tubes. The modular system allows to build tables in different sizes and heights. All legs are equipped with adjusters.*

### PIANO TAVOLO / TABLE TOP

legno/wood

pag. 214

melaminico/melamine

pag. 202

laminato/laminate

pag. 204

hpl

pag. 206

REGOLABILE / ADJUSTABLE 

### PIEDE / FOOT

acciaio/steel

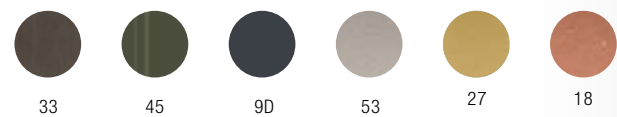
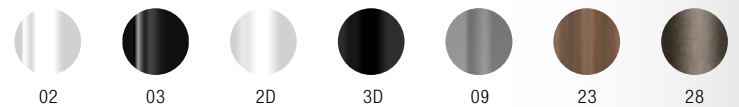

acciaio inox/stainless steel

\*OUTDOOR USE 

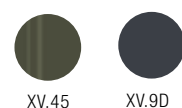

# bridge

## TABLE BASE



BT.212 / 213

Spalla / Frame da 78 cm	Spalla / Frame da 98 cm	Spalla / Frame da 108 cm
78 x 118 x H.73 – TOP: 80 x 120 cm	98 x 118 x H.73 – TOP: 100 x 120 cm	118 x 118 x H.73 – TOP: 120 x 120 cm
78 x 138 x H.73 – TOP: 80 x 140 cm	98 x 138 x H.73 – TOP: 100 x 140 cm	118 x 138 x H.73 – TOP: 120 x 140 cm
78 x 158 x H.73 – TOP: 80 x 160 cm	98 x 158 x H.73 – TOP: 100 x 160 cm	118 x 158 x H.73 – TOP: 120 x 160 cm



corbetta





nevada

TABLE BASE



## corbetta

### SISTEMA MODULARE / MODULAR SYSTEM

Sistema modulare con giunti per costruire strutture per tavoli.  
Le strutture sono costruite con tubi d'acciaio a sezione quadrata.  
La componibilità della struttura permette di costruire tavoli  
in diverse dimensioni ed altezze. Tutte le gambe sono dotate di regolabile.

*Modular system with connection joints to build tables structure formed by square section steel tubes. The modular system allows to build tables in different sizes and heights. All legs are equipped with adjusters.*

### PIANO TAVOLO / TABLE TOP

legno/wood	pag. 214
melaminico/melamine	pag. 202
laminato/laminate	pag. 204
hpl	pag. 206

### PIEDE / FOOT

#### acciaio/steel

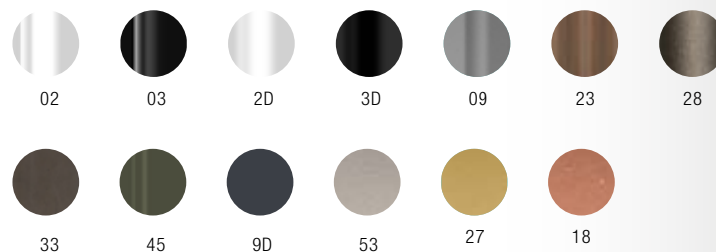

#### acciaio inox/stainless steel

\*OUTDOOR USE 

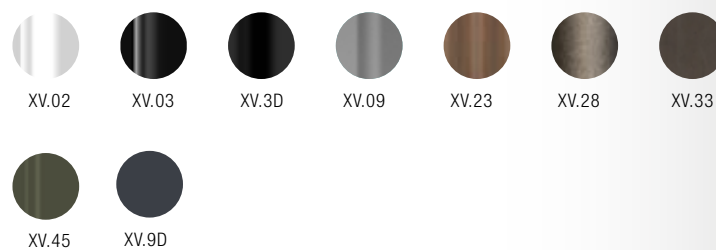

nevada

TABLE BASE



REGOLABILE / ADJUSTABLE 

BT.208 / BT209 / BT 209P

per TOP 70x120 cm	TOP 70x140 cm	TOP 70x160 cm
118X70 CM – H.73 cm 118X70 CM – H.107 cm	138X70 CM – H.73 cm 138X70 CM – H.107 cm	158X70 CM – H.73 cm 158X70 CM – H.107 cm









**corbetta**



*flexo A*

TABLE BASE





## corbetta

### PIANO TAVOLO / TABLE TOP

legno/wood pag. 214

melaminico/melamine pag. 202

laminato/laminate pag. 204

Spessore minimo / Minimum thickness  
2.4 / 2.5 cm

### PIEDE / FOOT

acciaio/steel

RUOTE DISPONIBILI / WHEELS AVAILABLE 



01



03



09

\* DISPONIBILE IN VERSIONE FISSA/ FIXED VERSION AVAILABLE

# flexo A

## TABLE BASE



**flexo 1\***



K6023 set 2 pcs

Top min 70 x 120 cm

L 43 cm.	H 71 cm.	B 59.6 cm.
----------	----------	------------

\*DISPONIBILE IN VERSIONE FISSA / AVAILABLE IN FIXED VERSION

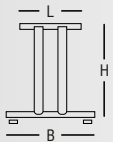

**flexo 1 R180**



K6023R180 set 3 pcs

K6023/40 set 2 pcs

Top min R180: Ø 180 cm  
Top min 40: 50 x 120 cm

L 34 cm.	H 71 cm.	B 40 cm.
----------	----------	----------



**flexo 2\***



K6027 set 2 pcs

Top min 70 x 120 cm

L 43 cm.	H 71 cm.	B 58 cm.
----------	----------	----------

\*DISPONIBILE IN VERSIONE FISSA / AVAILABLE IN FIXED VERSION

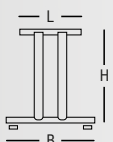

**flexo 1 R160**



K6023R160 set 3 pcs

Top min R160: Ø 160 cm

L 25 cm.	H 71 cm.	B 20 cm.
----------	----------	----------



corbetta



**flexo 2 big**

K 6 0 4 6 set 2 pcs

Top min 70 x 120 cm

L 43 cm.	H 71 cm.	B 79 cm.
----------	----------	----------



**flexo 15**

K 6 0 4 0 set 2 pcs

Top min 70 x 120 cm

L 43 cm.	H 71/107 cm.	B 60 cm.
----------	--------------	----------



# flexo A

## TABLE BASE



**flexo 3**



K 6 0 1 1 set 2 pcs

Top min 80 x 80 cm

L 60 cm.	H 71 cm.	B 60 cm.
----------	----------	----------



**flexo 3 big**



K 6 0 1 2 set 2 pcs

Top min Ø 160 cm - 110 x 110 cm

L 100 cm.	H 71 cm.	B 100 cm.
-----------	----------	-----------

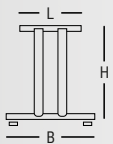

**flexo 20**

K 6 0 3 1 set 2 pcs

Top min 70 x 120 cm

L 43 cm.	H 71 cm.	B 53 cm.
----------	----------	----------



**flexo 21**

K 6 0 3 2 set 2 pcs

Top min 70 x 120 cm

L 43 cm.	H 71 cm.	B 60 cm.
----------	----------	----------

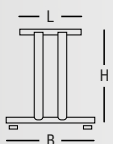

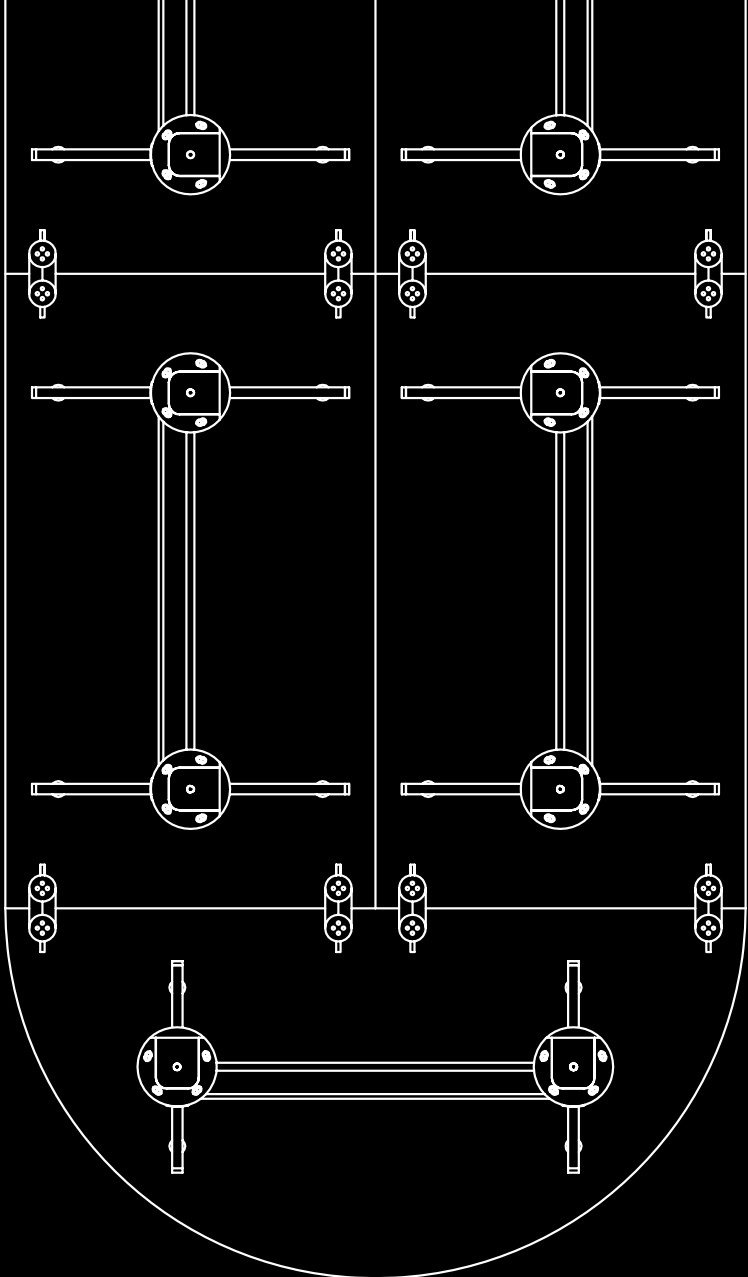

**corbetta**  
DESIGN FOR LIVING

**FELXO A BREVETTATO / PATENTED**

Meccanismo di chiusura realizzato in acciaio zincato ad alta resistenza. Permette la chiusura e l'apertura dei fianchi tavolo tramite la semplice pressione della leva posta nella parte superiore del meccanismo.  
*Closing mechanism made of high resistance steel. Allows the closing and opening of the table frame through the pressure of the lever placed in the upper part of the mechanism.*



**GIUNTO PER TAVOLI / EXTENSION SYSTEM**

Giunto in plastica. Consente di unire e bloccare la posizione dei tavoli una volta che i piani sono affiancati tra loro.  
*Plastic joint. Block the table position once the tops are placed side by side.*



BARRE DI RINFORZO / REINFORCING BARS

GIUNTO / JOINT





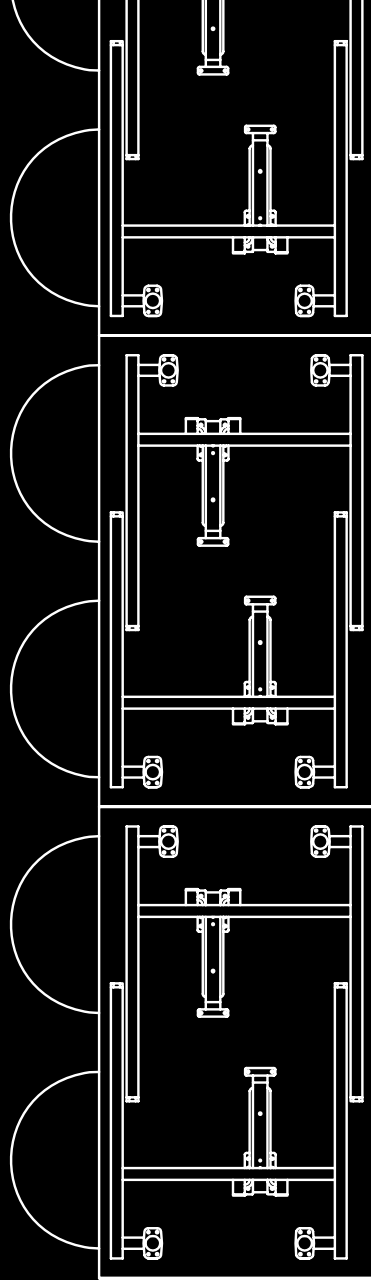

# flexo A/B

## TABLE BASE

FLEXXO A - Strutture di elementi tubolari in acciaio predisposte con appositi attacchi e di meccanismo per fissaggio al piano. Il meccanismo è dotato di sistema di bloccaggio dei fianchi sia a tavolo aperto che chiuso. Dotate di piedini regolabili. I tavoli che adottano questo sistema di basi possono essere sovrapposti, pallettizzati e impilati.

*Tubular steel frame complete with connections and mechanism for top fixing. The mechanism is equipped with a frame locking system when table is open or close. Adjustable feet included. With this frame system tables can be stackable and piled up on pallets.*

FLEXXO B - Strutture di elementi tubolari in acciaio predisposte con meccanismo ribaltabile in plastica ad alta resistenza per il ribaltamento dei piani. Tutte le strutture sono dotate di piedini regolabili. I tavoli che adottano questo sistema di basi possono essere sovrapposti, pallettizzati e impilati.

*Metal bases provided with opening/closing top mechanism can be releases by pulling red lever. Mechanism is made by high strong plastic. All frames are equipped with adjustable feet. The tables which take this base system can be stacked, stacked on pallet.*

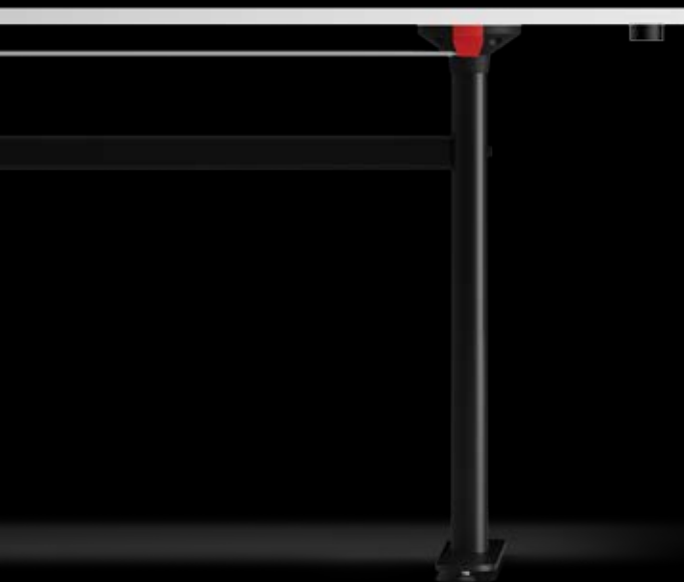

**corbetta**

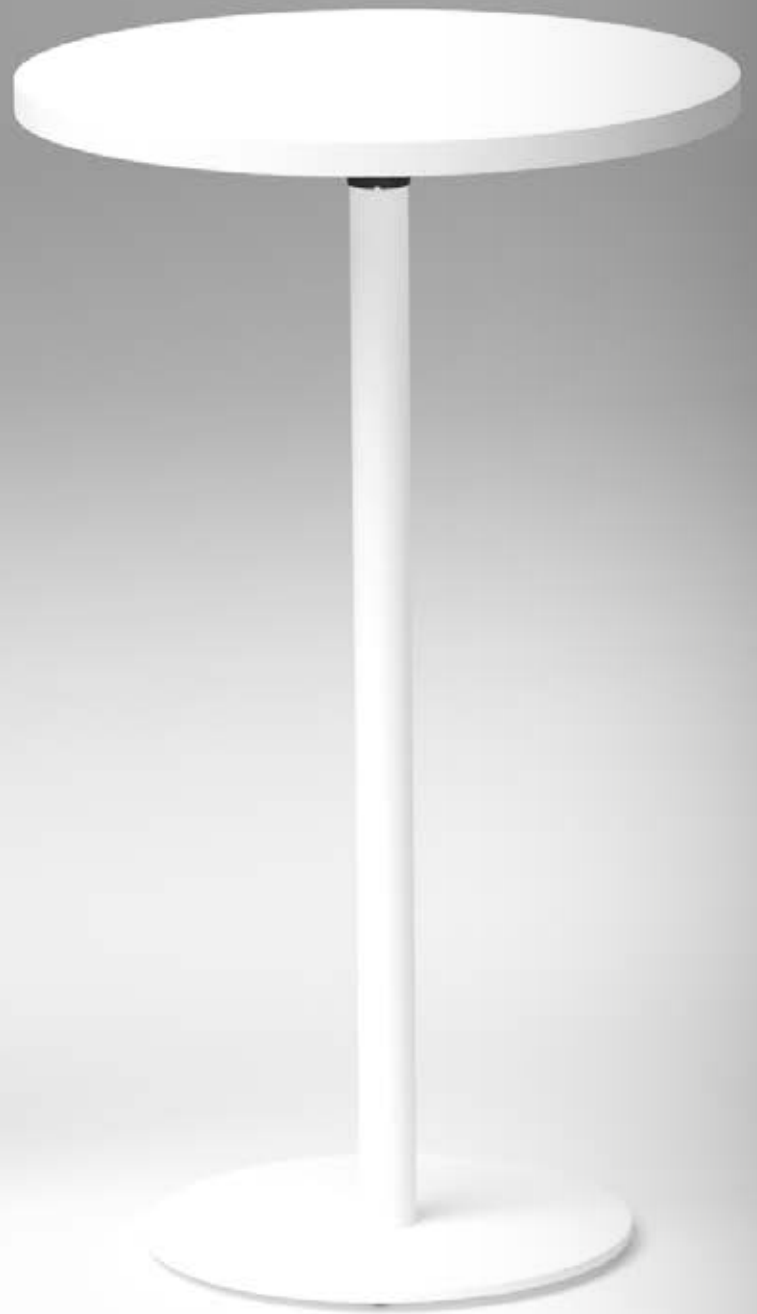

*flexo B*

TABLE BASE





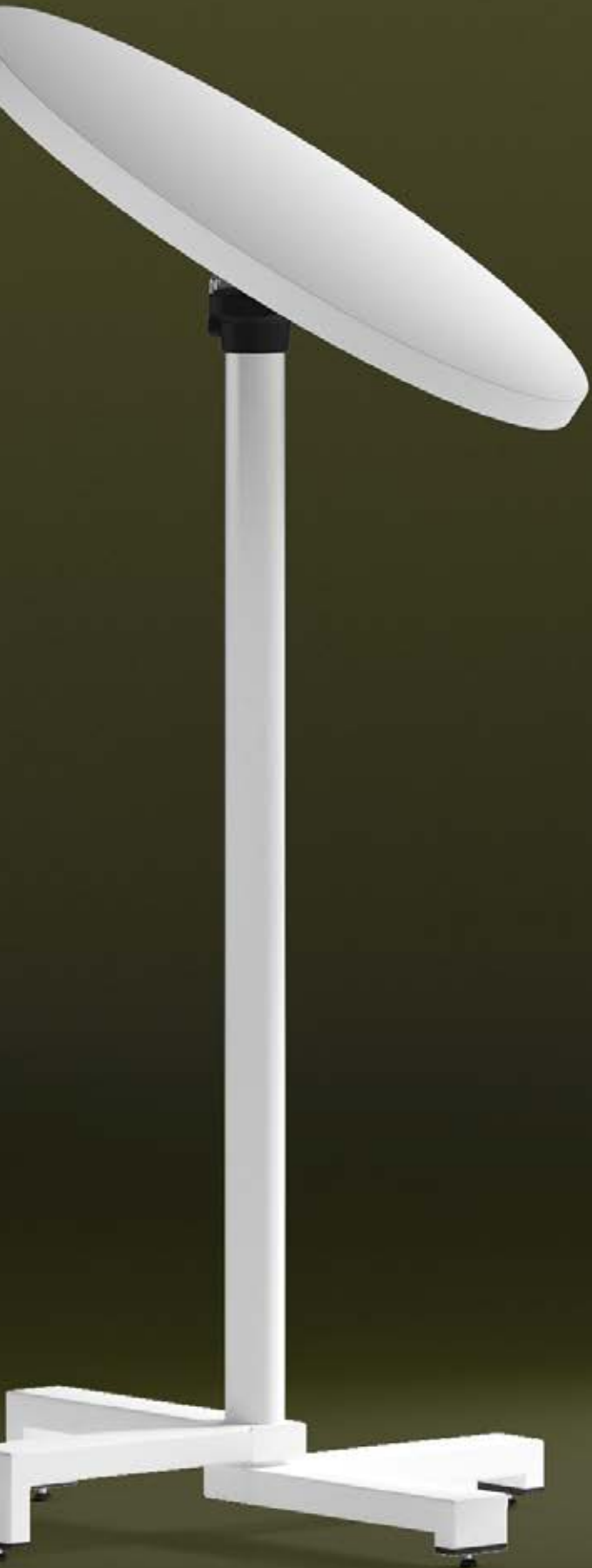



## corbetta

### PIANO TAVOLO / TABLE TOP

legno/wood	pag. 214
melaminico/melamine	pag. 202
laminato/laminate	pag. 204
hpl	pag. 206

#### IMPORTANTE / IMPORTANT

Per un miglior ancoraggio al piano consigliamo di inserire nel top delle bussole in metallo  
*To have a frame better fixing we suggest me- tal insert in the tops.*

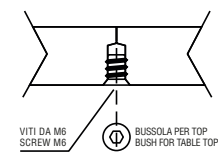

### PIEDE / FOOT

#### acciaio/steel

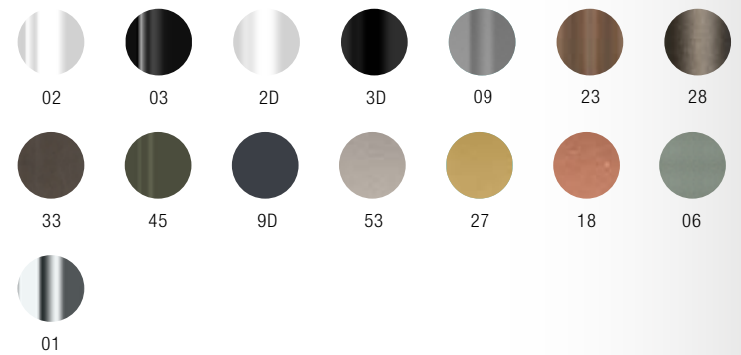

#### acciaio inox/stainless steel

\*OUTDOOR USE ☁️

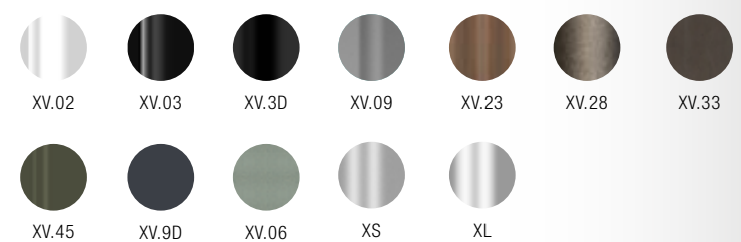

# flexo B

## TABLE BASE



**flexo 4**

K0298

L. min	80 x 80 cm	B.	-
H.	71 cm	S.	Ø 5 cm



**flexo 16\***

K30937

L. max	Ø 80 cm 70x70 cm h.71	B.	Ø 44 cm
	Ø 70 cm 60x60 cm h.107		
H.	71/107 cm	S.	Ø 5 cm



**flexo 17\***

K30938

L. max	Ø 80 cm 70x70 cm h.71	B.	Ø 44 cm
	Ø 70 cm 60x60 cm h.107		
H.	71/107 cm	S.	Ø 5 cm

REGOLABILE / ADJUSTABLE

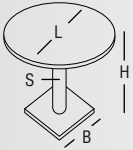

**flexo 18**

K30942

L. max	Ø 70 cm 70x70 cm h.71	B.	Ø 58 cm
H.	71/107 cm	S.	Ø 5 cm



**flexo 19**

K30943

L. max	Ø 80 cm 70x70 cm h.71	B.	Ø 58 cm
	Ø 70 cm 60x60 cm h.107		
H.	71/107 cm	S.	Ø 5 cm

REGOLABILE / ADJUSTABLE

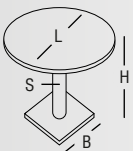



corbetto



# flexo B

## TABLE BASE



**flexo 5**

K 3 0 9 3 3

<b>L. max</b>	Ø 80 cm 70x70 cm h.71	<b>B.</b> Ø 58 cm
	Ø 70 cm 60x60 cm h.107	
<b>H.</b>	71/107 cm	<b>S.</b> Ø 5 cm



**flexo 14**

K 3 0 9 4 0

<b>L. max</b>	Ø 70 cm	<b>B.</b> Ø 55 cm
	<b>H.</b> 71 cm	
IMPILABILE / STACKABLE		



**flexo 23**

K 3 0 9 4 5

<b>L. max</b>	Ø 80 cm 70x70 cm h.71	<b>B.</b> Ø 58 cm
	Ø 70 cm 60x60 cm h.107	
<b>H.</b>	71/107 cm	<b>S.</b> Ø 5 cm

INOX DISPONIBILE / AVAILABLE



**flexo 28**

K 3 0 9 4 8

<b>L. max</b>	Ø 80 cm 70x70 cm h.71	<b>B.</b> Ø 58 cm
	Ø 70 cm 60x60 cm h.107	
<b>H.</b>	71/107 cm	<b>S.</b> Ø 5 cm

IMPILABILE / STACKABLE - 4 pcs MAX  
INOX DISPONIBILE / AVAILABLE

REGOLABILE / ADJUSTABLE

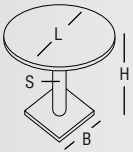

REGOLABILE / ADJUSTABLE

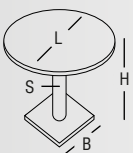



**corbetta**

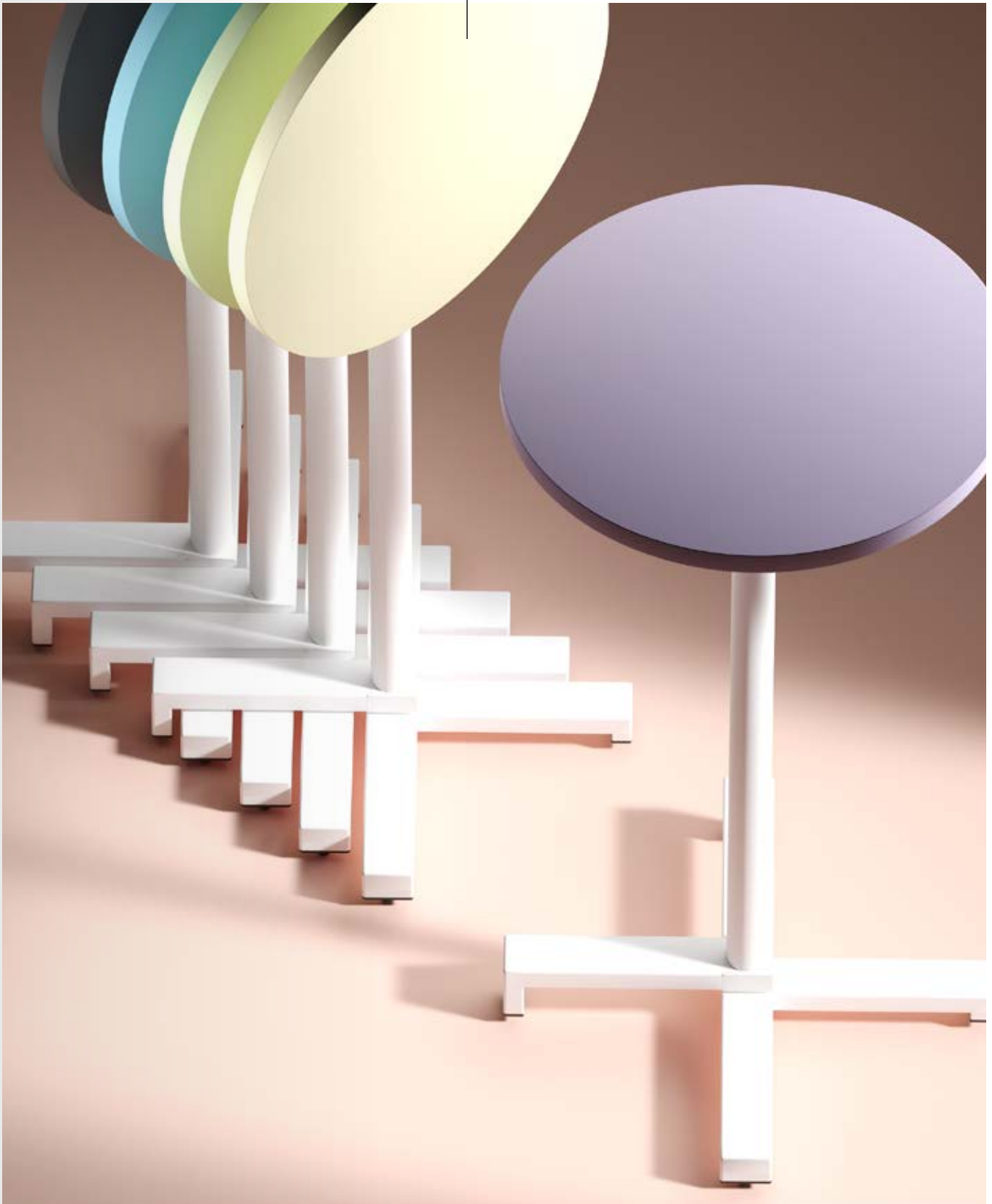





**corbetta**

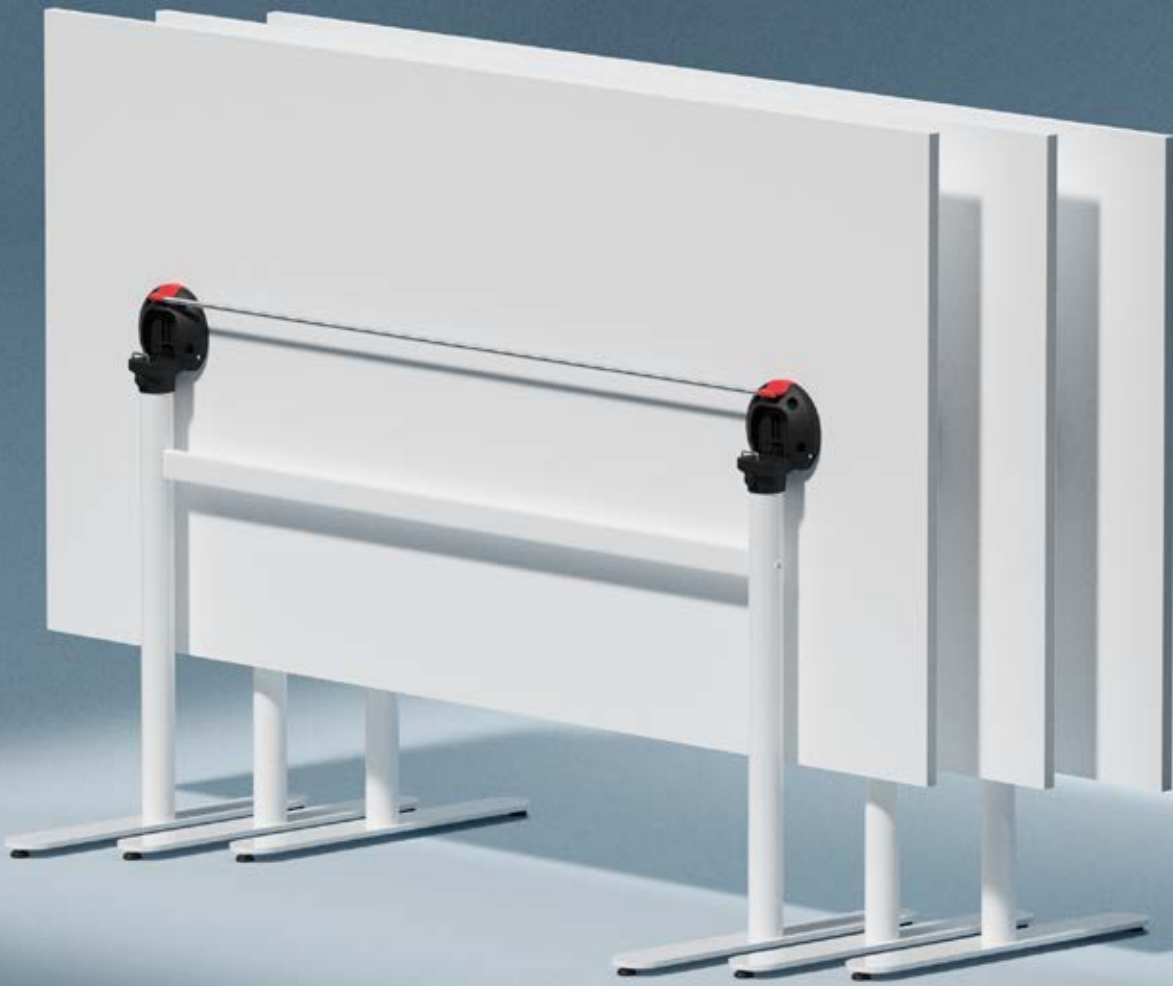

# flexo B

## TABLE BASE



REGOLABILE / ADJUSTABLE 

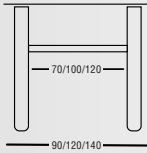

TR. 070 - 90 x 140 cm  
TR. 100 - 90 x 160 cm  
TR. 120 - 90 x 180 cm  
TOP MAX

**flexo 7\***

K30934



TR crossbar	TR. 070 / 100 / 120	B.	Ø 58 cm
H.	71 cm	S.	Ø 5 cm

\*DISPONIBILE IN VERSIONE FISSA / AVAILABLE IN FIXED VERSION

**flexo 8\***

K30932



TR crossbar	TR. 070 / 100 / 120	B.	Ø 60 cm
H.	71 cm	S.	Ø 5 cm

\*DISPONIBILE IN VERSIONE FISSA / AVAILABLE IN FIXED VERSION

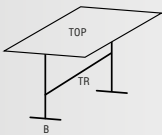

REGOLABILE / ADJUSTABLE 

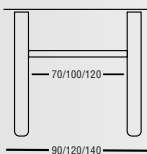

TR. 070 - 90 x 140 cm  
TR. 100 - 90 x 160 cm  
TR. 120 - 90 x 180 cm  
TOP MAX

**flexo 24\***

K30946



TR crossbar	TR. 070 / 100 / 120	B.	Ø 58 cm
H.	71 cm	S.	Ø 5 cm

\*DISPONIBILE IN VERSIONE FISSA / AVAILABLE IN FIXED VERSION

**flexo 25**

K30947

TR crossbar	TR. 070 / 100 / 120	B.	Ø 58 cm
H.	71 cm	S.	Ø 5 cm

\*DISPONIBILE IN VERSIONE FISSA / AVAILABLE IN FIXED VERSION

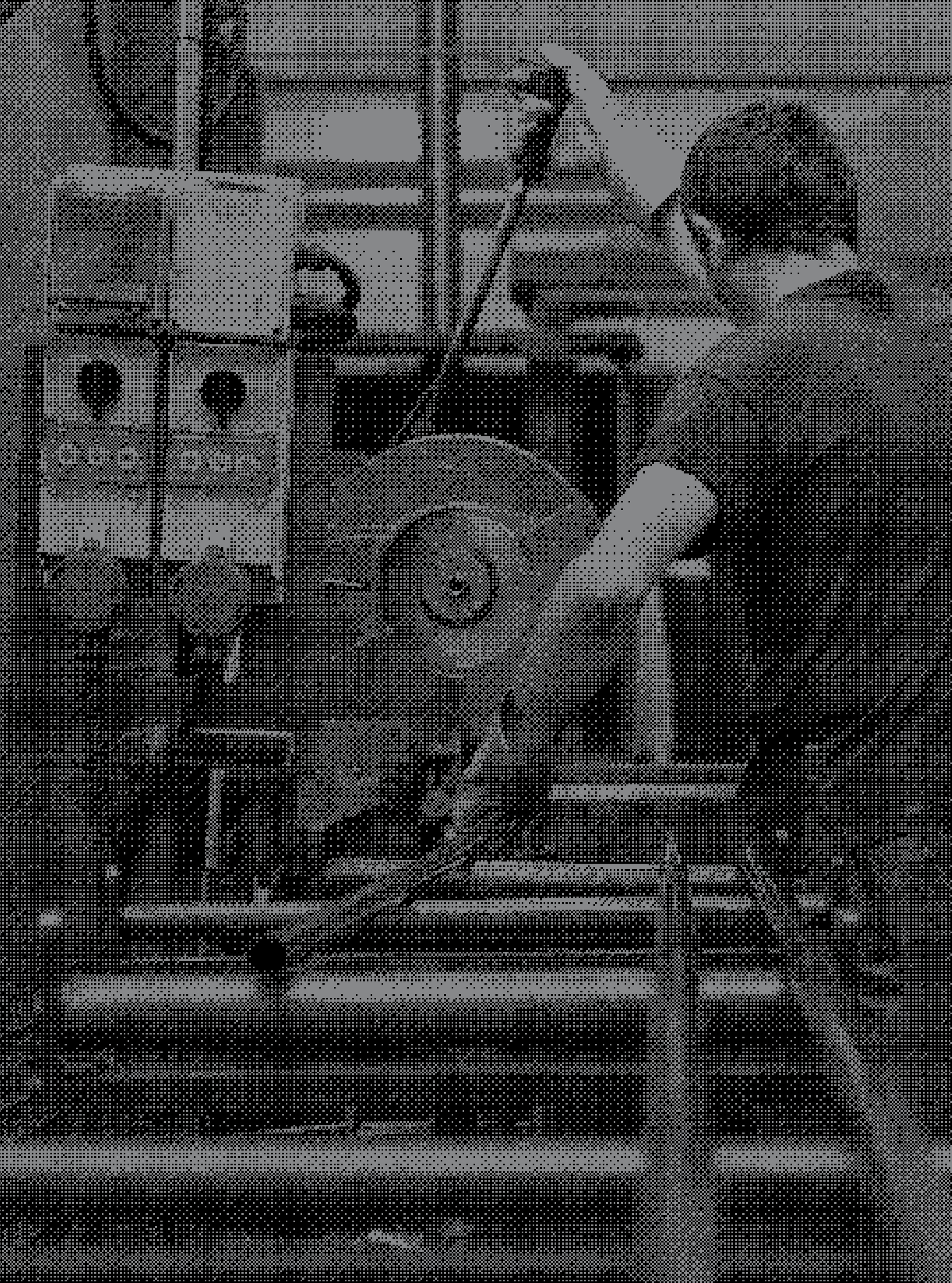





corbetta

CHAIRS

2022

corbetta



pepper

CHAIRS









## corbetta



### SEDUTA / SEAT legno/wood



NATURALE



VINTAGE



OKUMÉ\*

### laminato/laminate

pag. 204

### imbottito/upholstered

- TESSUTO / FABRIC
- ECOPELLE / ECO-LEATHER

pag. 222  
pag. 224

### FUSTO / FRAME acciaio/steel

\*OUTDOOR USE



02\*



03\*



2D



3D\*



09\*



23\*



28\*



06\*



33\*



45\*



9D\*



53



27



18

# pepper

## CHAIRS



SE.1021

L.	50 cm	P.	58 cm
H.	80 cm	S.	46 cm



SE.1022

L.	57 cm	P.	58 cm
H.	80 cm	S.	46 cm



SE.1023

L.	55 cm	P.	58 cm
H.	99/109 cm	S.	65/75 cm





## corbetta

### FULL COLORS

#### SEDUTA / SEAT

laminato/laminate ARPA



0561  
DARK RED



0517  
LIGHT GREEN



0566  
OCEAN BLUE



0525  
YELLOW



0682  
BRIGHT  
ORANGE

#### FUSTO / FRAME

acciaio/steel RAL



3020  
TRAFFIC RED



6019  
WHITENED  
GREEN



5015  
SKY BLUE



1034  
PASTELL  
YELLOW



2009  
TRAFFIC  
ORANGE



A close-up photograph of a modern chair with a vibrant red finish. The chair features a curved, tubular frame and a seat made of light-colored wood with a thin, curved wooden edge. The background is a solid, matching red color. The text 'pepper' is overlaid in a lowercase, sans-serif font, and 'CHAIRS' is in a smaller, uppercase, sans-serif font below it.

pepper

CHAIRS

corbetta



lexi

CHAIRS





## corbetta



### SEDUTA / SEAT legno/wood



NATURALE



VINTAGE

### laminato/laminate

pag. 204

### imbottito/upholstered

- TESSUTO / FABRIC
- ECOPELLE / ECO-LEATHER

pag. 222  
pag. 224

### FUSTO / FRAME acciaio/steel

\*OUTDOOR USE



02\*



03\*



2D



3D\*



09\*



23\*



28\*



06\*



33\*



45\*



9D\*



53



27



18

lexi

CHAIRS



SE.1012

L.	50 cm	P.	53 cm
H.	80 cm	S.	46 cm



SE.1016

L.	50 cm	P.	53 cm
H.	80 cm	S.	46 cm



SE.1017

L.	50 cm	P.	53 cm
H.	80 cm	S.	46 cm

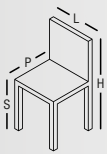

SE.1013

L.	55 cm	P.	55 cm
H.	100/110 cm	S.	65/75 cm



SE.1019

L.	55 cm	P.	55 cm
H.	100/110 cm	S.	65/75 cm



SE.1024

L.	55 cm	P.	55 cm
H.	100/110 cm	S.	65/75 cm

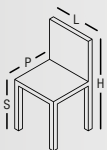



## corbetta

### FULL COLORS

#### SEDUTA / SEAT

laminato/laminate ARPA



0561  
DARK RED



0517  
LIGHT GREEN



0566  
OCEAN BLUE



0525  
YELLOW



0682  
BRIGHT  
ORANGE

#### FUSTO / FRAME

acciaio/steel RAL



3020  
TRAFFIC RED



6019  
WHITENED  
GREEN



5015  
SKY BLUE



1034  
PASTELL  
YELLOW



2009  
TRAFFIC  
ORANGE

lexi

CHAIRS



**corbetta**







*celine*

CHAIRS



## corbetta

### SEDUTA / SEAT

imbottito/upholstered

- ECOPELLE / ECO-LEATHER pag. 224
- VERA PELLE / REAL LEATHER pag. 226
- TESSUTO / FABRIC pag. 222

### FUSTO / FRAME

acciaio/steel

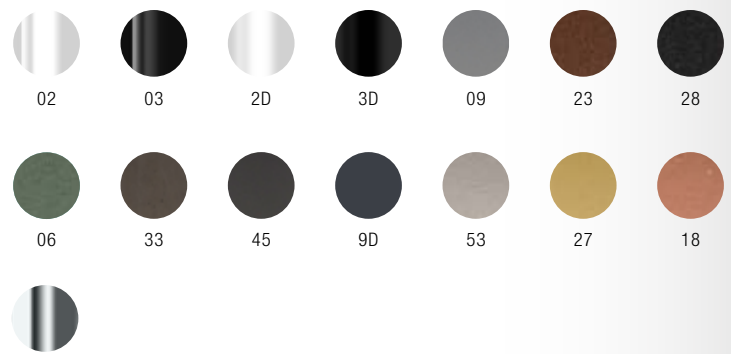

01 solo/only 1080 - 1078 - 1079 - 1081

# celine

## CHAIRS



SE.1080

L. 53 cm	P. 51 cm
H. 86 cm	S. 47 cm



SE.1078

L. 48 cm	P. 52 cm
H. 85 cm	S. 47 cm



SE.1079

L. 52 cm	P. 53 cm
H. 86/96 cm	S. 65/75 cm

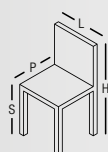

SE.1081

L. 53 cm	P. 51 cm
H. 86 cm	S. 45 cm



SE.1083

L. 53 cm	P. 51 cm
H. 86 cm	S. 45 cm



SE.1084

L. 52 cm	P. 53 cm
H. 86/96 cm	S. 65/75 cm

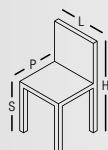

**corbetta**



*afrodite*

CHAIRS





## corbetta

### SEDUTA / SEAT

imbottito/upholstered

- ECOPELLE / ECO-LEATHER pag. 224
- VERA PELLE / REAL LEATHER pag. 226
- TESSUTO / FABRIC pag. 222

### FUSTO / FRAME

acciaio/steel

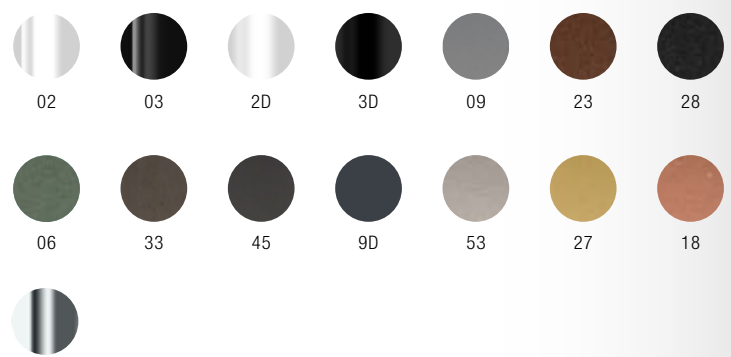

# afrodite

## CHAIRS



SE.1005

L. 48 cm	P. 52 cm
H. 85 cm	S. 47 cm



SE.1007

L. 52 cm	P. 53 cm
H. 86 cm	S. 65/75 cm



SE.1008

L. 53 cm	P. 51 cm
H. 86 cm	S. 45 cm

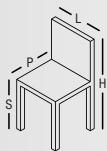

SE.1009

L. 53 cm	P. 51 cm
H. 86 cm	S. 45 cm



SE.1003

L. 48 cm	P. 52 cm
H. 85 cm	S. 47 cm



SE.1004

L. 52 cm	P. 53 cm
H. 86 cm	S. 65/75 cm

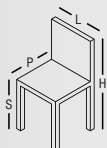

**corbetta**







*cubica*

CHAIRS



## corbetta

### SEDUTA / SEAT

imbottito/upholstered

- ECOPELLE / ECO-LEATHER pag. 224
- VERA PELLE / REAL LEATHER pag. 226
- TESSUTO / FABRIC pag. 222

### FUSTO / FRAME

acciaio/steel

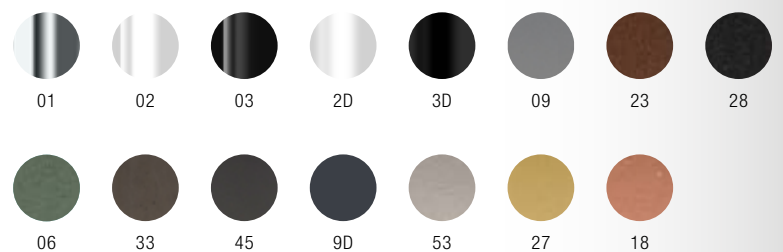

# cubica

## CHAIRS



SE.0151

L. 41 cm	P. 49 cm
H. 84 cm	S. 45 cm



SE.0152

L. 41 cm	P. 49 cm
H. 85/95 cm	S. 65/75 cm



SE.0153

L. 90/100 cm	P. 49 cm
H. 84 cm	S. 45 cm



**corbetta**



*stripes*

CHAIRS





## corbetta



### SEDUTA / SEAT cinghie/straps



Cinghie sintetiche con elevata resistenza ai raggi UVA. Adatte ad applicazioni esterne.  
Synthetic straps with high resistance to UV. Suitable for outdoor use.

### FUSTO / FRAME acciaio/steel

\*OUTDOOR USE 

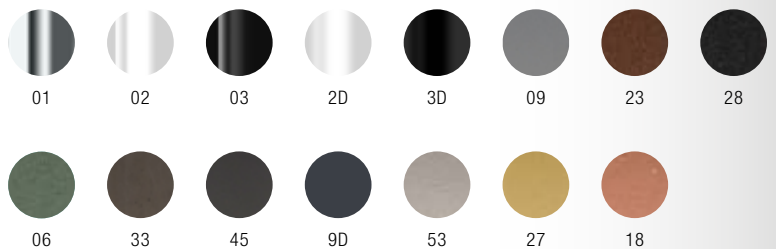

# stripes

## CHAIRS

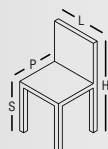

SE.1055



L. 50 cm	P. 52 cm
H. 83 cm	S. 45 cm

SE.1056

L. 50 cm	P. 52 cm
H. 83 cm	S. 45 cm

SE.1057

L. 52 cm	P. 52 cm
H. 83/93 cm	S. 65/75 cm

**corbetta**







jolie

CHAIRS



## corbetta

### SEDUTA / SEAT imbottito/upholstered

- ECOPELLE / ECO-LEATHER
- TESSUTO / FABRIC

pag. 224

pag. 222

### FUSTO / FRAME acciaio/steel

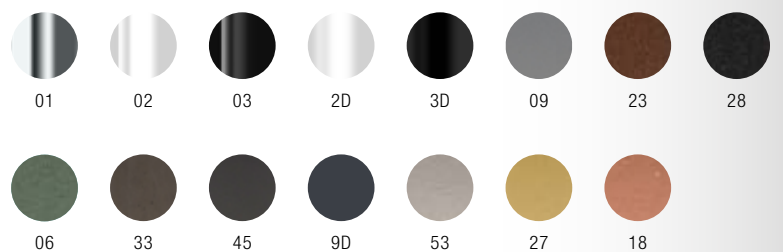

# jolie

## CHAIRS



SE.0716



L. 45 cm	P. 50 cm
H. 82 cm	S. 47 cm



SE.0718



L. 52 cm	P. 55 cm
H. 100/110 cm	S. 65/75 cm



SE.0719

L. 45 cm	P. 45 cm
H. 65/75 cm	S. 65/75 cm

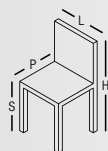

corbetta



sorriso

CHAIRS





## corbetta

### SEDUTA / SEAT imbottito/upholstered

- ECOPELLE / ECO-LEATHER pag. 224
- VERA PELLE / REAL LEATHER pag. 226
- TESSUTO / FABRIC pag. 222

GIREVOLE / SWIVEL

### FUSTO / FRAME acciaio/steel

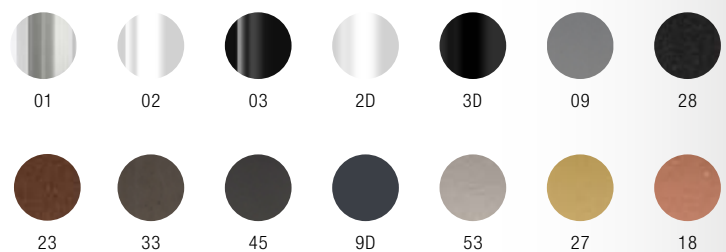

# sorriso

## CHAIRS



SE.0420

L. 48 cm	P. 52 cm
H. 85 cm	S. 47 cm



SE.0422

L. 48 cm	P. 52 cm
H. 85 cm	S. 47 cm



SE.0423

L. 48 cm	P. 52 cm
H. 85 cm	S. 47 cm



SE.0425

L. 48 cm	P. 52 cm
H. 85 cm	S. 47 cm

GIREVOLE / SWIVEL

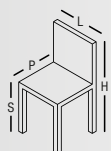

corbetta





*fifty*

CHAIRS





## corbetta

### SEDUTA / SEAT

imbottito/upholstered

• ECOPELLE / ECO-LEATHER

pag. 224

disponibile con bordo BIANCO o NERO

available with WHITE or BLACK edge

### FUSTO / FRAME

acciaio/steel

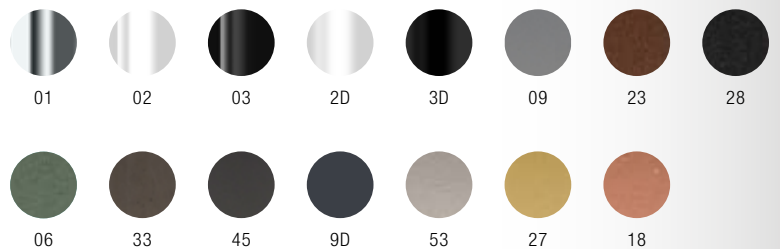

*fifty*

CHAIRS



SE.0710

L. 45 cm	P. 50 cm
H. 82 cm	S. 47 cm

SE.0712

L. 52 cm	P. 55 cm
H. 100/110 cm	S. 65/75 cm

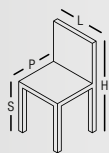



**corbetta**



**corbetta**



*diva*

CHAIRS



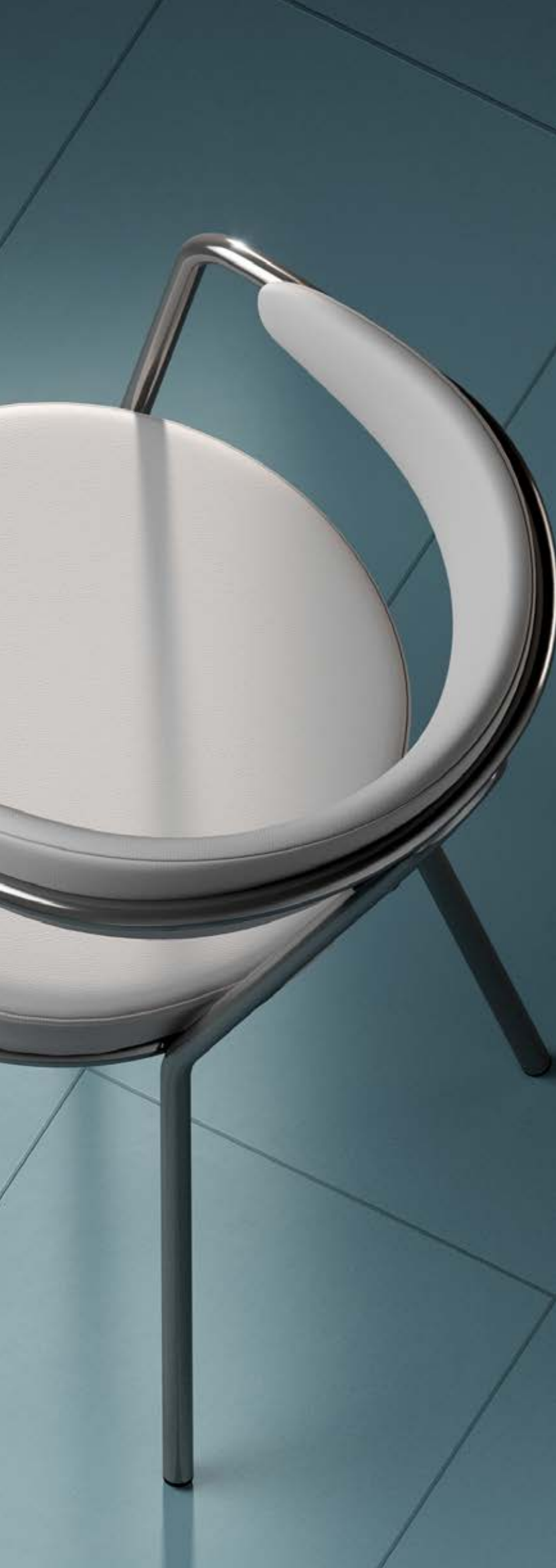

## corbetta

**SEDUTA / SEAT**  
imbottito/upholstered

• ECOPELLE / ECO-LEATHER

pag. 224

**FUSTO / FRAME**  
acciaio/steel

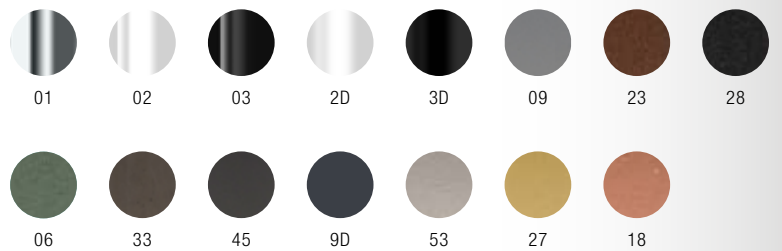



*diva*

CHAIRS



SE.0158

L. 50 cm	P. 58 cm
H. 78 cm	S. 47 cm

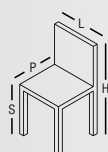

**corbetta**





*milena*

CHAIRS



## corbetta

### SEDUTA / SEAT imbottito/upholstered

- ECOPELLE / ECO-LEATHER
- TESSUTO / FABRIC

pag. 224

pag. 222

### FUSTO / FRAME acciaio/steel

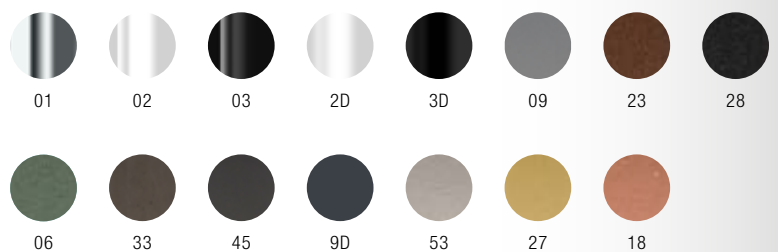

*milena*

CHAIRS



SE.0702



IMPILABILE  
STACABILE

L. 40 cm	P. 46 cm
H. 84 cm	S. 46 cm

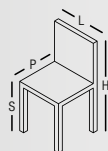

**corbetta**





pamela

CHAIRS



## corbetta



**SEDUTA / SEAT**  
legno/wood



NATURALE

laminato/laminate

pag. 204

**FUSTO / FRAME**  
acciaio/steel



01



02



03



2D



3D



09



23



28



06



33



45



9D



53



27



18



# pamela

## CHAIRS

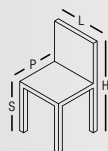

SE.0703



L. 45 cm	P. 50 cm
H. 82 cm	S. 47 cm

SE.0706



L. 52 cm	P. 55 cm
H. 100/110 cm	S. 65/75 cm





## corbetta

### SEDUTA / SEAT

imbottito/upholstered

• ECOPELLE / ECO-LEATHER

pag. 224

disponibile con bordo BIANCO o NERO

available with WHITE or BLACK edge

### FUSTO / FRAME

acciaio/steel

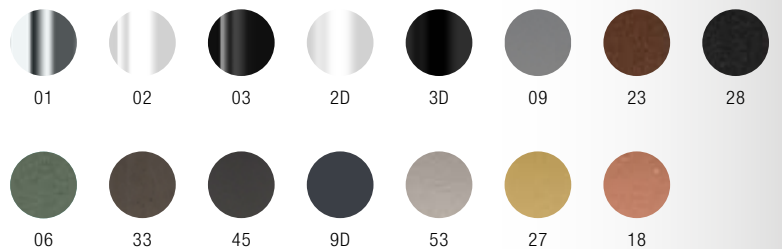

# charlie

## CHAIRS



SE.0164

L. 45 cm	P. 58 cm
H. 80 cm	S. 48 cm



SE.0165

L. 50 cm	P. 60 cm
H. 108 cm	S. 75 cm

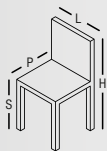



## corbetta

### SEDUTA / SEAT imbottito/upholstered

- ECOPELLE / ECO-LEATHER
- TESSUTO / FABRIC

pag. 224

pag. 222

### FUSTO / FRAME acciaio/steel

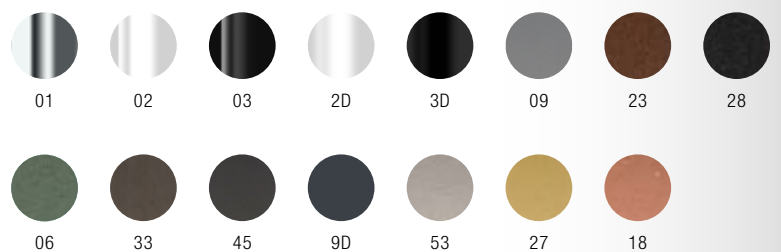

geo

CHAIRS



SE.0188

L. 36 cm	P. 36 cm
H. 65/75 cm	S. 65/75 cm

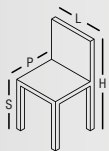



## corbetta

### SEDUTA / SEAT imbottito/upholstered

- ECOPELLE / ECO-LEATHER pag. 224
- VERA PELLE / REAL LEATHER pag. 226
- TESSUTO / FABRIC pag. 222

GIREVOLE / SWIVEL

### FUSTO / FRAME acciaio/steel

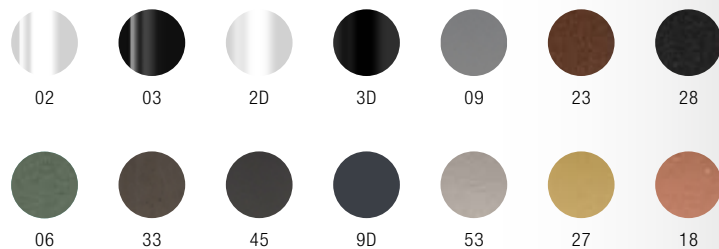

# tree

## TABLE BASE & STOOL



SE.0590

L. Ø44 cm <b>max</b>	B. Ø 44 cm
H. 65/75 cm	S. 8 cm



BT.115

L. Ø80 70x70 cm <b>max</b>	B. Ø 44 cm
H. 107 cm	S. 8 cm

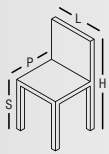

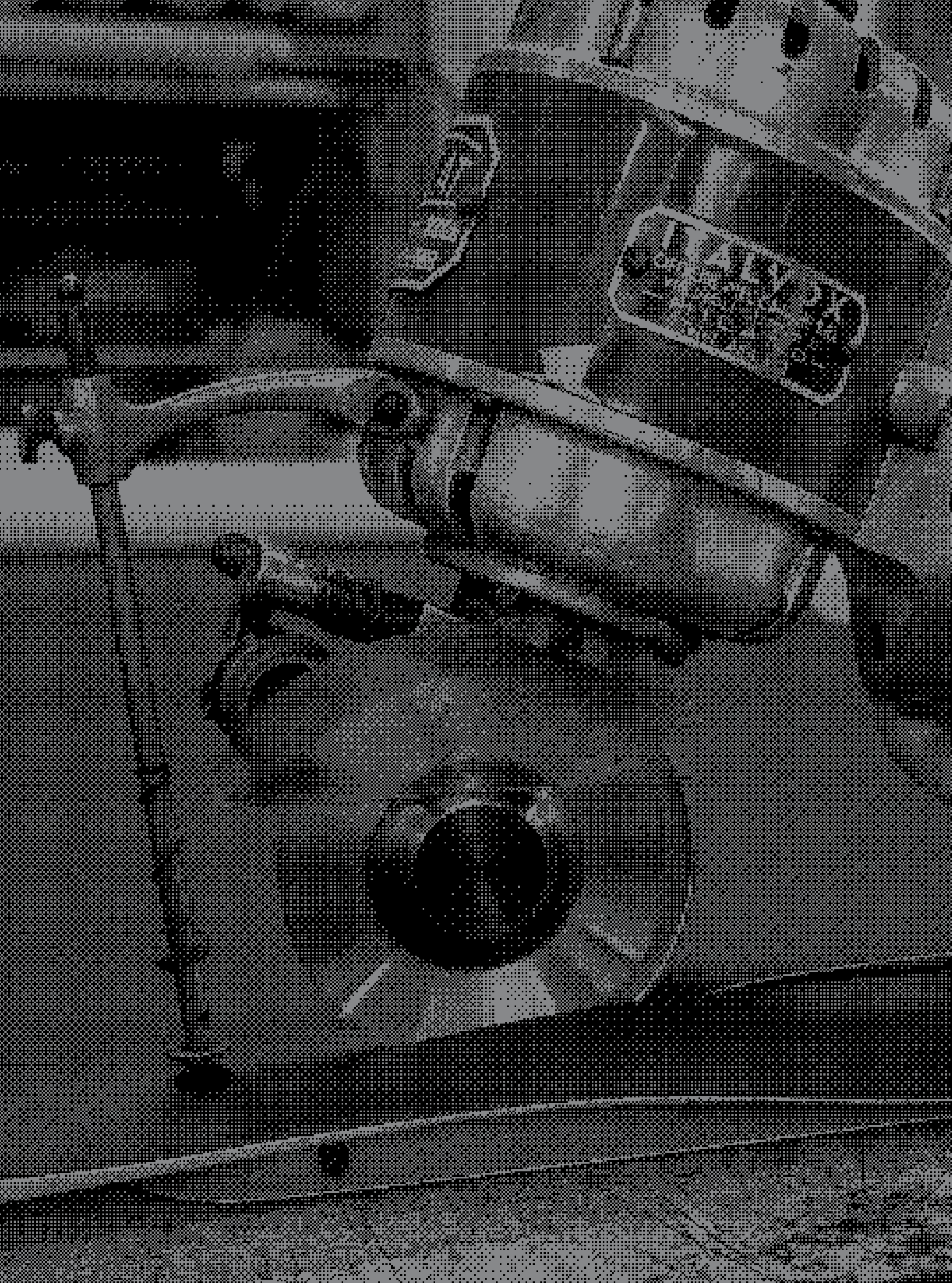





**corbetta**

FINITURE / FINISHES

2022



## corbetta

Tutti i colori dei materiali e delle finiture illustrate hanno solo valore indicativo in quanto soggetti alle tolleranze dei processi di stampa.

*Colors of materials and finishes are indicative as they depend on printing process.*



### USO INTERNO / ESTERNO INDOOR / OUTDOOR USE

LE VERNICI SI INTENDONO **PER ESTERNO** IN QUANTO NON SUBISCONO VARIAZIONI DI COLORE NEL TEMPO A CAUSA DEI RAGGI UVA.

*THE PAINTS ARE FOR **OUTDOOR** SINCE THEY ARE NOT SUBJECT TO COLORS UVA VARIATIONS*

# acciaio/steel

## finiture / finishes

### acciaio / steel finitura galvanica / galvanic finishes



01  
Cromo  
*Chrome*



07  
Ottonato  
*Brass*

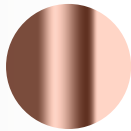

12  
Rame Lucido  
*Copper*



### acciaio / steel verniciato a polverev/ powder coated



02 RAL 9003 \*  
Bianco lucido  
*Gloss white*



03 RAL 9005 \*  
Nero lucido  
*Gloss black*



2D RAL 9010  
Bianco opaco  
*Matt white*

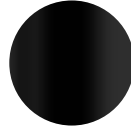

2D RAL 9005 \*  
Nero opaco  
*Matt black*



09 RAL 9006 \*  
Alluminio  
*Aluminium*

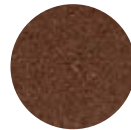

23 \*  
Corten  
*Corten*



28 \*  
Grafite  
*Graphite*



33 \*  
Trasparente (grezzo)  
*Transparent (raw)*



45 RAL 7022 \*  
Grigio umbro  
*Grey umbro*



9D RAL 7016 \*  
Grigio scuro opaco  
*Dark gray matt*



53  
Champagne  
*Champagne*



27 RAL \*  
Oro verniciato  
*Painted gold*

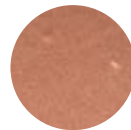

18 RAL \*  
rame verniciato  
*Painted copper*

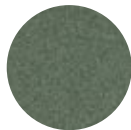

06 \*  
Verde salvia  
*Sage green*



### acciaio / steel inox / stainless

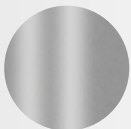

XS  
Inox satinato  
*Inox satin*

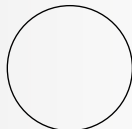

XV 02 / 03 / 3D / 06 / 09 / 13 / 18 / 23 / 27 / 28 / 33 / 45 / 46  
Inox verniciato  
*Inox painted*

**corbetta**

Tutti i colori dei materiali e delle finiture illustrate hanno solo valore indicativo in quanto soggetti alle tolleranze dei processi di stampa.

*Colors of materials and finishes are indicative as they depend on printing process.*

**BORDO / EDGE**

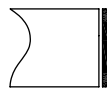

**ABS / ABS**

spessore / thickness  
20 mm / 24 mm / 30 mm

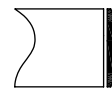

**ABS<sup>ottonato</sup> / ABS<sup>satinato</sup> / ABS<sup>brass</sup>**

spessore / thickness  
20 mm / 24 mm / 30 mm

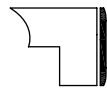

**ABS / ABS**

spessore / thickness  
50 mm

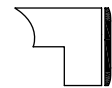

**ABS<sup>ottonato</sup> / ABS<sup>satinato</sup> / ABS<sup>brass</sup>**

spessore / thickness  
50 mm

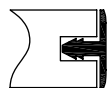

**PVC NERO / BLACK PVC**

spessore / thickness  
24 mm

# laminato/laminate

finiture / finishes



USO INTERNO  
INDOOR USE

## laminato / laminate S standard



Bianco  
*White*



Beige  
*Beige*



Grigio chiaro  
*Light grey*

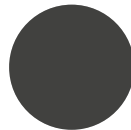

Antracite  
*Dull grey*

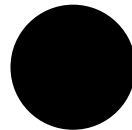

Nero  
*Black*

## laminato opaco / laminate matte SOFT TOUCH C standard



8857  
Giallo  
*Yellow*



8245  
Verde salvia  
*Sage green*



8238  
Cipria  
*Blush*



7674  
Marmo Veneto  
*Veneto Marble*



7402  
Pietra Grafite  
*Stone*



9483  
Pietra Ferro  
*Iron Stone*



9485  
Pietra Nera  
*Black Stone*

## laminato lucido / bright laminate C standard



3460  
Marmo Calacatta  
*Calacatta Marble*



3476  
Jet Sequoia  
*Black Marble*

## laminato / laminate C standard



4407  
Cemento  
*Concrete*

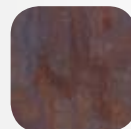

4398  
Corten  
*Corten*



4399  
Ferro ossidato  
*Rusty iron*



4101  
Rovere sbiancato  
*Whitened oak*

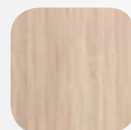

1001  
Rovere naturale  
*Natural oak*

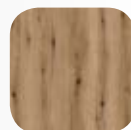

5573  
Legno Evoke  
*Evoke wood*

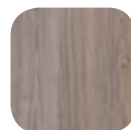

4417  
Legno grigio  
*Grey wood*

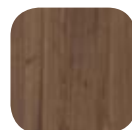

5280  
Legno tabacco  
*Tobacco wood*



4456  
Legno scuro  
*Dark wood*



**corbetta**

Tutti i colori dei materiali e delle finiture illustrate hanno solo valore indicativo in quanto soggetti alle tolleranze dei processi di stampa.

*Colors of materials and finishes are indicative as they depend on printing process.*



**USO INTERNO / ESTERNO**  
**INDOOR / OUTDOOR USE**

LE VERNICI SI INTENDONO **PER ESTERNO** IN QUANTO NON SUBISCONO VARIAZIONI DI COLORE NEL TEMPO A CAUSA DEI RAGGI UVA.

*THE PAINTS ARE FOR **OUTDOOR** SINCE THEY ARE NOT SUBJECT TO COLORS UVA VARIATIONS*

**BORDO / EDGE**



**DRITTO / STRAIGHT**

spessore / thickness  
10 mm / 12 mm



**SVASATO / INCLINED**

spessore / thickness  
10 mm / 12 mm

# laminato hpl/hpl laminate

## finiture / finishes



USO INTERNO/ESTERNO  
INDOOR/OUTDOOR USE

### laminato hpl / hpl laminate standard / standard



0001 Arpa  
Bianco  
*White*

12mm  
Cuore nero  
*Black heart*



0244 Arpa  
Avorio  
*Ivory*

12mm  
Cuore nero  
*Black heart*



0527 Arpa  
Grigio chiaro  
*Light grey*

12mm  
Cuore nero  
*Black heart*



0526 Arpa  
Grigio scuro  
*Dark grey*

12mm  
Cuore nero  
*Black heart*



0509 Arpa  
Nero  
*Black*

12mm  
Cuore nero  
*Black heart*



### laminato hpl / hpl laminate pietra & legno / stone & wood

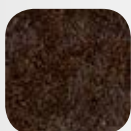

3276 Arpa  
Fiammato rosso  
*Red flame*

12mm  
Cuore marrone  
*Brown heart*



3349 Arpa  
Fiammato nero  
*Black flame*

12mm  
Cuore nero  
*Black heart*



4587 Arpa  
Rovere Slavonia  
*Slavonia oak*

12mm  
Cuore marrone  
*Brown heart*



4586 Arpa  
Rovere Texas  
*Texas oak*

12mm  
Cuore marrone  
*Brown heart*



4517 Arpa  
Rovere carbone  
*Carbon oak*

12mm  
Cuore marrone  
*Brown heart*



3192 Arpa  
Cemento  
*Concrete*

12mm  
Cuore nero  
*Black heart*

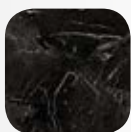

6076  
Impero

12mm  
Cuore nero  
*Black heart*



PU 6231  
Marmetto

12mm  
Cuore nero  
*Black heart*



PU 6116  
Nuvolento

12mm  
Cuore in tinta  
*Same color heart*

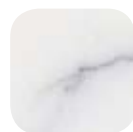

5547  
Statuario

12mm  
Cuore nero  
*Black heart*



**corbetta**

Tutti i colori dei materiali e delle finiture illustrate hanno solo valore indicativo in quanto soggetti alle tolleranze dei processi di stampa.

*Colors of materials and finishes are indicative as they depend on printing process.*

**BORDO / EDGE**



**ABS / ABS**

spessore / thickness  
19 mm / 25 mm

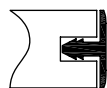

**PVC NERO / BLACK PVC**

spessore / thickness  
25 mm



# melaminico/melamine

finiture / finishes



USO INTERNO  
INDOOR USE

## melaminico / melamine colori / colors



Bianco  
*White*



Beige  
*Beige*



Grigio chiaro  
*Light grey*

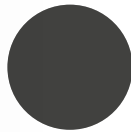

Antracite  
*Dull grey*

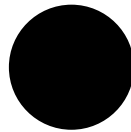

Nero  
*Black*

## melaminico / melamine legno / wood



4407  
Cemento  
*Concrete*

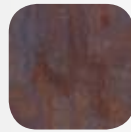

4398  
Corten  
*Corten*



4399  
Ferro ossidato  
*Rusty iron*



4101  
Rovere sbiancato  
*Whitened oak*

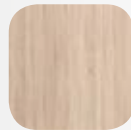

1001  
Rovere naturale  
*Natural oak*

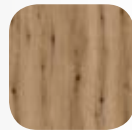

5573  
Legno Evoke  
*Evoke wood*



4417  
Legno grigio  
*Grey wood*



5280  
Legno tabacco  
*Tobacco wood*



4456  
Legno scuro  
*Dark wood*



## corbetta

Tutti i colori dei materiali e delle finiture illustrate hanno solo valore indicativo in quanto soggetti alle tolleranze dei processi di stampa.

*Colors of materials and finishes are indicative as they depend on printing process.*

### BORDO / EDGE

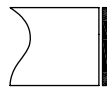

#### ABS

spessore / thickness  
20 mm

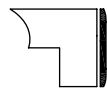

#### ABS

spessore / thickness  
50 mm

laminato / diamond  
diamante / laminate

finiture / finishes



USO INTERNO  
INDOOR USE

**laminato tinta unita / full color laminate**  
lucido / polished

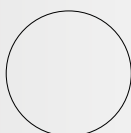

vedi / see  
pag. 205





## corbetta

Tutti i colori dei materiali e delle finiture illustrate hanno solo valore indicativo in quanto soggetti alle tolleranze dei processi di stampa.

*Colors of materials and finishes are indicative as they depend on printing process.*

### TIPOLOGIA / TYPES

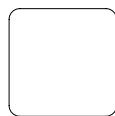

quadrato / square

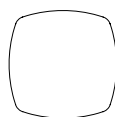

botte / barrel

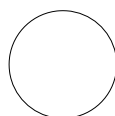

rotondo / round

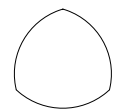

triangolare / triangle

### BORDO / EDGE

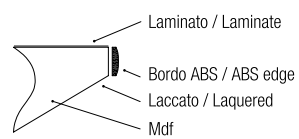

### ABS

spessore / thickness

30 mm

laminato / 'vaso'  
'vaso' / laminated

finiture / finishes



USO INTERNO  
INDOOR USE

**laminato / laminate**  
**'vaso' / 'vase'**

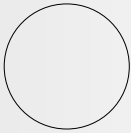

Bianco  
*White*



Nero  
*Black*



## corbetta

Tutti i colori dei materiali e delle finiture illustrate hanno solo valore indicativo in quanto soggetti alle tolleranze dei processi di stampa.

*Colors of materials and finishes are indicative as they depend on printing process.*

Interno in MDF con impiallacciatura foglio vero legno.

*MDF heart with wood veneer sheet.*

### BORDO / EDGE



### LEGNO MASSELLO / SOLID WOOD

spessore / thickness

40 mm

Piano listellato rovere tinto. Bordo piatto in legno massello.  
*Painted oak top with knots. Flat solid wood edge.*

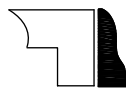
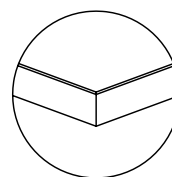
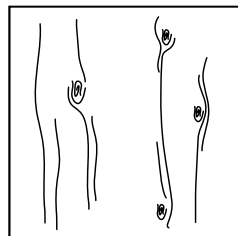

### CORTECCIA IRREGOLARE / IRREGULAR BARK

spessore / thickness

40 mm

Piano listellato rovere tinto.  
- 2 lati corti: bordo piatto in legno massello  
- 2 lati lunghi: bordo in corteccia irregolare  
*Painted oak top with knots.*  
- 2 short sides: flat solid wood edge  
- 2 long sides: irregular bark edge

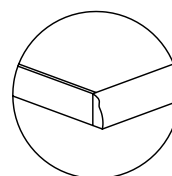
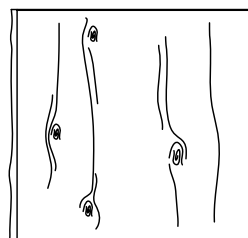

rovere / 7 knots  
7 nodi / oak

finiture / finishes



USO INTERNO  
INDOOR USE

rovere 7 nodi / 7 knots oak  
legno / wood

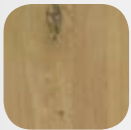

Tinto naturale  
*Natural painted*



Tinto grigio  
*Grey painted*



Tinto noce  
*Walnut painted*





## corbetta

Tutti i colori dei materiali e delle finiture illustrate hanno solo valore indicativo in quanto soggetti alle tolleranze dei processi di stampa.

*Colors of materials and finishes are indicative as they depend on printing process.*

Piano con doghe in legno tinto trattato in autoclave resistente all'acqua.  
Bordo in acciaio effetto grezzo.

*Top with wooden slats with water resistant treatment.  
With steel edge*

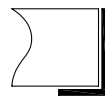

### FERRO TINTO GREZZO / PAINTED STEEL RAW

spessore / thickness

40 mm

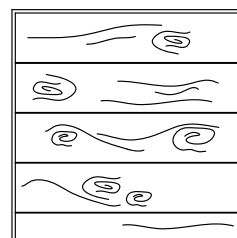



doghe / wood  
legno / strips

finiture / finishes



USO INTERNO/ESTERNO  
INDOOR/OUTDOOR USE

legno / wood



Tinto grigio  
*Grey painted*



Tinto noce  
*Walnut painted*



## corbetta

Tutti i colori dei materiali e delle finiture illustrate hanno solo valore indicativo in quanto soggetti alle tolleranze dei processi di stampa.

*Colors of materials and finishes are indicative as they depend on printing process.*

### BORDO / EDGE



### DRITTO / STRAIGHT

spessore / thickness  
18 mm



### SVASATO / INCLINED

spessore / thickness  
18 mm

# eucalipto/eucalyptus

finiture / finishes



USO INTERNO/ESTERNO  
INDOOR/OUTDOOR USE

legno / wood



Tinto naturale  
*Natural painted*



Tinto nero  
*Black painted*



## corbetta

Piano a doghe di legno riciclate. **ATTENZIONE!** Questi piani potrebbero riportare difetti, macchie e stampe dovuti a precedenti utilizzi. Tutti i piani risultano essere diversi tra loro, non è possibile garantire nessun tipo di omogeneità!

*Top with recycled wood slats. **WARNING!** These tops could show defects, stains and stamps due to previous uses. All the tops are different from each other, it is not possible to guarantee any uniformity*

### BORDO / EDGE

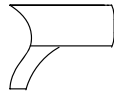

### LEGNO / WOOD

spessore / thickness

40 mm

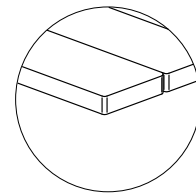
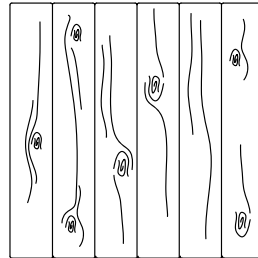

TIPO/TYPE A

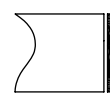
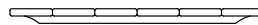

### LEGNO MASSELLO / SOLID WOOD

spessore / thickness

35 mm

Bordo piatto in legno massello.  
*Flat solid wood edge.*

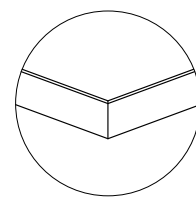
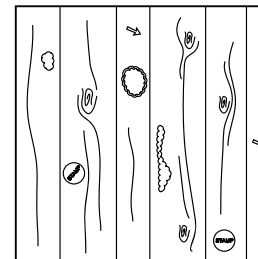

TIPO/TYPE B



legno / recycled  
riciclato / wood

finiture / finishes



USO INTERNO  
INDOOR USE



TIPO/TYPE A



TIPO/TYPE B





## corbetta

Tutti i colori dei materiali e delle finiture illustrate hanno solo valore indicativo in quanto soggetti alle tolleranze dei processi di stampa.

*Colors of materials and finishes are indicative as they depend on printing process.*

# tessuti/fabrics

## finiture / finishes



Ignifugo classe 1  
Fireproof class 1

### tessuti / fabrics gamma / range B 51% TREVIRA - 49% PL

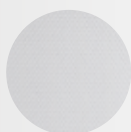

06926.10  
Bianco  
White

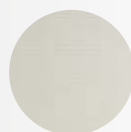

06926.01  
Beige  
Beige

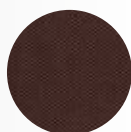

06926.20  
Marrone  
Brown



06926.35  
Rosso  
Red

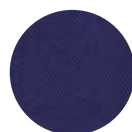

06926.50  
Blu  
Blue

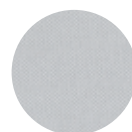

06926.03  
Grigio chiaro  
Light grey



06926.05  
Grigio scuro  
Dark grey



06926.06  
Nero  
Black



Ignifugo classe 1  
Fireproof class 1

### tessuti / fabrics gamma / range C 100% PES

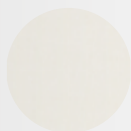

STRATOS.01  
Bianco  
White

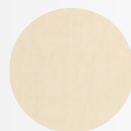

STRATOS.20  
Beige  
Beige



STRATOS.32  
Marrone  
Brown



STRATOS.08  
Rosso  
Red

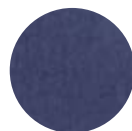

STRATOS.17  
Blu  
Blue



STRATOS.112  
Grigio chiaro  
Light grey



STRATOS.13  
Grigio scuro  
Dark grey



STRATOS.15  
Nero  
Black



**antimacchia** si pulisce solo con acqua  
**antistain** you can clean with jut water



Ignifugo classe 1 IM  
Fireproof class 1 IM

### tessuti / fabrics gamma / range G Reviva 100% PET recycled



Hero 401  
Beige chiaro  
Light beige



Hero 307  
Ocra  
Ocher

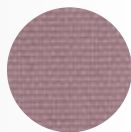

Hero 901  
Rosa  
Pink



Hero 801  
Verde  
Green



Hero 602  
Grigio  
Grey



Hero 711  
Azzurro  
Light blue



Hero 701  
Blu  
Blue



Hero 200  
Nero  
Black

Tessuto realizzato al 100% con plastica riciclata.  
Fabric made with recycled plastic bottles.



## corbetta

Tutti i colori dei materiali e delle finiture illustrate hanno solo valore indicativo in quanto soggetti alle tolleranze dei processi di stampa.

*Colors of materials and finishes are indicative as they depend on printing process.*



# eco-pelle/eco-leather

## finiture / finishes



Ignifugo classe 1 IM  
Fireproof class 1 IM

### eco-pelle / eco-leather gamma / range A 100% PVC

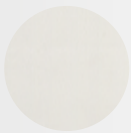

10000  
Bianco  
White



9327  
Grigio chiaro  
Light grey



12741  
Grigio scuro  
Dark grey



11783  
Marrone chiaro  
Light brown



9269  
Testa di moro  
Dark brown



9290  
Rosso  
Red



9806  
Blu  
Blue



10001  
Nero  
Black



Ignifugo classe 1 IM  
Fireproof class 1 IM

### eco-pelle / eco-leather gamma / range B 90% PVC - 10% PA



636.02  
Bianco  
White



636.04  
Beige chiaro  
Light beige



636.13  
Beige scuro  
Dark beige



636.06  
Marrone  
Brown



636.05  
Giallo  
Yellow

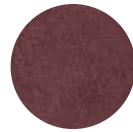

636.10  
Bordeaux  
Bordeaux

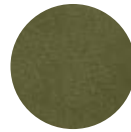

636.11  
Verde  
Green

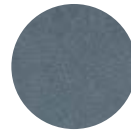

636.12  
Azzurro  
Light blue



636.14  
Grigio  
Grey

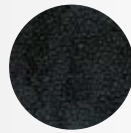

636.15  
Nero  
Black



## corbetta

Tutti i colori dei materiali e delle finiture illustrate hanno solo valore indicativo in quanto soggetti alle tolleranze dei processi di stampa.

*Colors of materials and finishes are indicative as they depend on printing process.*

# vera pelle/real leather

## finiture / finishes



### cuoio / leather 100%

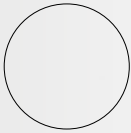

DELTA 010  
Bianco  
*White*



DELTA 311  
Beige  
*beige*



DELTA 090  
Marrone chiaro  
*Light brown*



DELTA 029  
Testa di moro  
*Dark brown*



DELTA 130  
Rosso  
*Red*



DELTA 008  
Blu  
*Blue*



DELTA 1062  
Antracite  
*Dark grey*



Nero  
*Black*

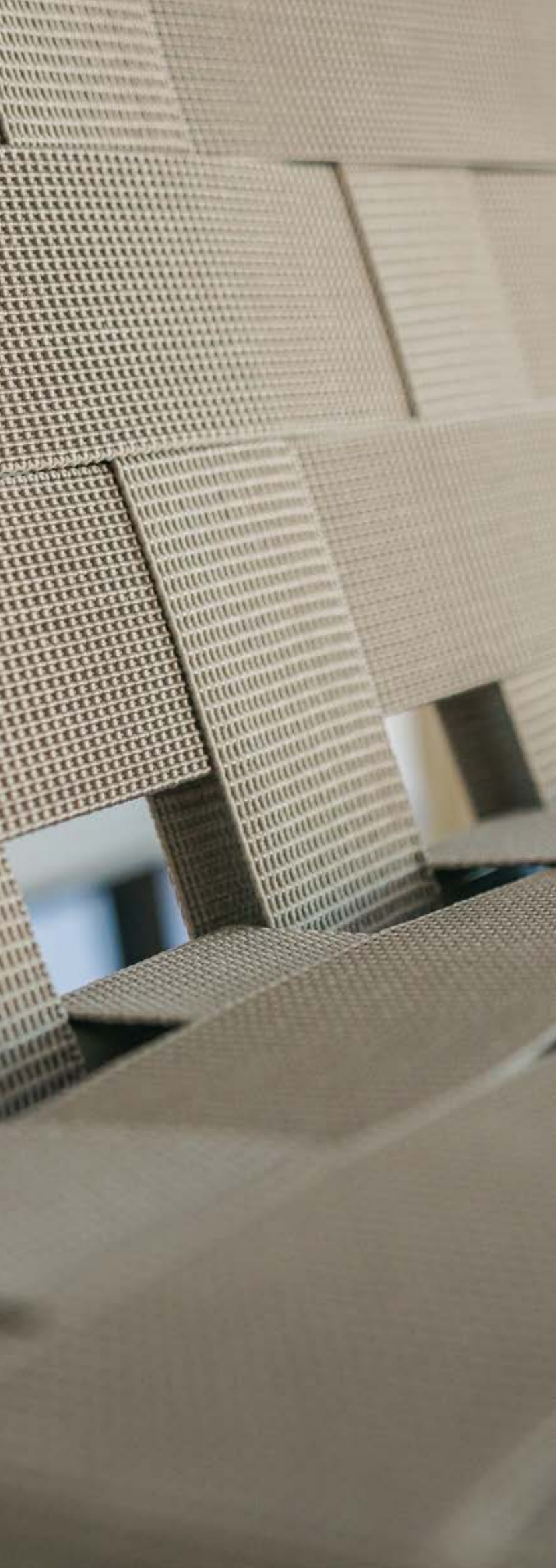

## corbetta

Tutti i colori dei materiali e delle finiture illustrate hanno solo valore indicativo in quanto soggetti alle tolleranze dei processi di stampa.

*Colors of materials and finishes are indicative as they depend on printing process.*

# cinghie/stripes

finiture / finishes

## cinghie / stripes pvc

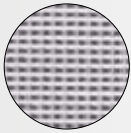

650 STW  
Bianco  
*White*

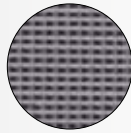

650 STGAL  
Grigio  
*Grey*



650 STMM  
Marrone  
*Brown*

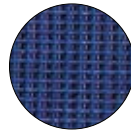

650 STAA  
Blu  
*Blue*



650 STN  
Nero  
*Black*

# **corbetta**

CORBETTA SALVATORE Srl  
Viale Lombardia, 18 - 23847 - Molteno (LC) - ITALY  
Tel. 0039 031 850575 - C.f. / P.Iva 00381720135  
info@corbettasalvatore.com - www.corbettasalvatore.com

100% MADE IN ITALY  
ISO 9001  
CERTIFICATO / CERTIFIED

progetto grafico e impaginazione: ADDUMA

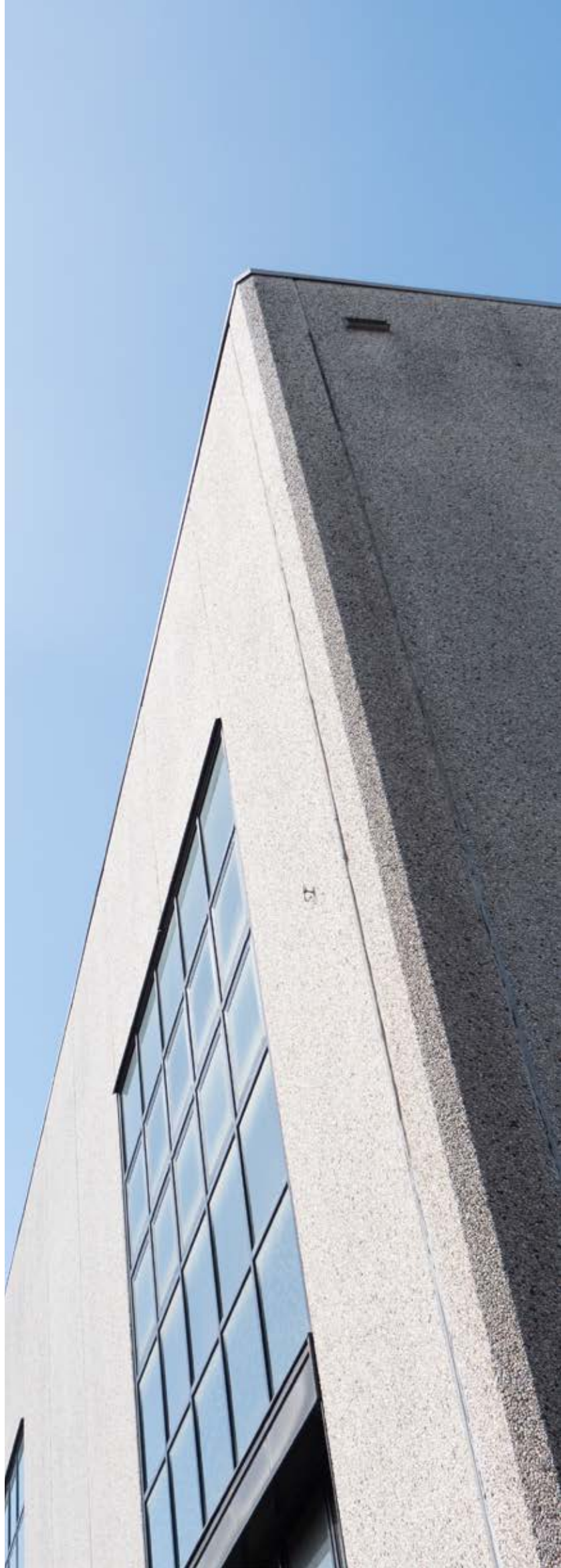

# corbetta



*Aménageur d'Espaces...*

[www.mbs95.com](http://www.mbs95.com)

15, rue de la Briqueterie 95330 DOMONT  
Tél. 01 39 35 41 80 Fax 01 39 35 41 76 [commercial@mbs95.com](mailto:commercial@mbs95.com)